

Magnicator®

Magnetic Liquid Level Products



The
Magnet
Matters™

JERGUSON®

A PRODUCT OF CLARK-RELIANCE

The Magnet Matt

A Superior Float Magnet Creates a

If you are looking for reliable performance from a magnetic level indicator, start with the float magnet. The stronger and more focused the magnetic field of the float, the more reliable the level indicator...and the more reliable the function of magnetically-actuated flag indicators, switches and transmitters.

The Jerguson® Magnicator float has the **strongest magnetic field of any magnetic level indicator**. Its unique design uses two 360° annular Alnico 8 ring magnets with opposing north poles.



Hermetically-Sealed Cylindrical Float (Standard)



Hermetically-Sealed High Pressure Spherical Float



Carrier-Style High Pressure Spherical Float

Magnicator®

Magnetic Liquid Level Indication Products

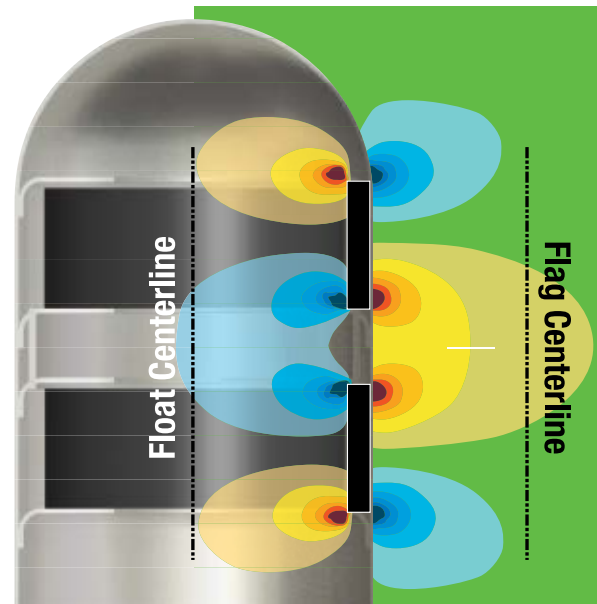

Magnetic Field Density Diagram of Magnicator Float

Reliability is in the physics. A uniquely strong north magnetic field activates flags, switches and transmitters with a certainty not found elsewhere because only the Magnicator has a magnet arrangement this powerful, and this focused.

Superior Level Indicator

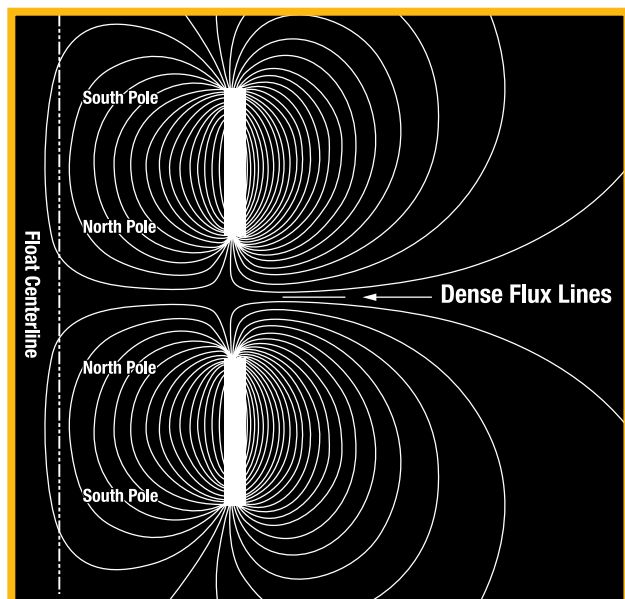

Magnetic Flux Density Plot of Magnicator Float

Opposing magnetic poles project concentrated flux lines away from the outside diameter of the magnets. This forced deflection creates a field stronger than any other float magnet arrangement, greater than 90 Gauss at the centerline of the indicator flags. Physics has guaranteed that the Magnicator float has the strongest magnetic field...which translates to the most reliable instrument.



Magnicator Float



Typical Float from other manufacturer

Typical floats from other manufacturers employ a circular array of Alnico 5 Bar Magnets. Other brands use a single ring magnet. Neither can produce as intense a magnetic field as the Magnicator float.

How it Works

The Magnicator® level indicator is connected to a process vessel. The chamber, or “column,” contains a sealed float with a permanent magnet assembly which rises and falls as the liquid level changes in the process vessel.

The indicator housing is parallel to the gage column but completely isolated from process liquid. Indicator flags are rotated by the float magnet assembly as it moves up and down in the chamber.

Magnetic liquid level indicators are an attractive alternative to sight glasses for many applications. They provide improved visibility, reduced maintenance and eliminate the leak paths associated with sealing glass.



Robust Construction *Inside and Out*

Your demanding application deserves a gage with the guts to stick it out for a long, long time. In addition to complying with ASME B31.1 for power piping and ASME B31.3 for process piping, all Magnicator® Magnetic Level Indicators incorporate additional design and construction benefits you will not find on any comparable product:

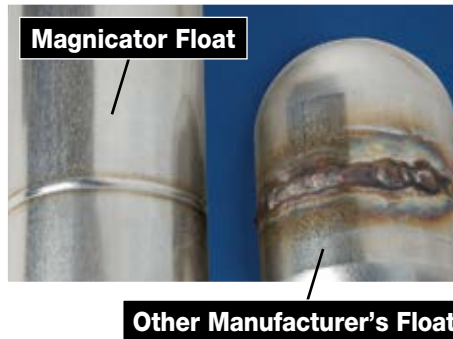

Schedule 40 Chamber Construction is Standard

Most other magnetic level indicators are offered as Sch 10, with an upgrade to Sch 40 available. Since most plant piping specifications prohibit Sch 10 pipe, this can be misleading. The difference between Sch 10 and Sch 40 is substantial, with a lower pressure rating and a much greater chance of damage during shipping, handling and construction. For even higher pressures, we offer Sch 80 and Sch 160 chambers. This is directly related to the strength of our patented float magnet assembly. No other magnetic level indicator can function as reliably with such robust piping.

Smooth Autogenous Welds

All standard cylindrical Magnicator floats have full penetration autogenous welds. This means an orbital welding machine has fusion-welded the two halves using only heat and no filler metal. This process—the same used for high purity and sanitary tubing—produces an ultra-smooth weld, without a bead which could interfere with the float's motion.



Sch 160

Sch 80

Sch 40

Sch 10

Schedule 160 and 80 Columns for High Pressure
The focused strength of the Magnicator float permits reliable operation in heavy wall chambers including Sch 160.

Schedule 40 construction is **standard** for Magnicator chambers.

Schedule 10 is not appropriate for most process applications.



Superior Indicators Mean *You Can Trust What You See*

*We took the most reliable indicator in the industry and gave you more of it.
Just another example of Jerguson taking indication to the #nextlevel.*



Jerguson® recommends flag indicators for virtually all applications, thus flags come as standard on Magnicator® products. However, there is nothing “standard” about their design and construction. They are the most reliable, shock-resistant and longest lasting available. And now, they’re also the widest!

The NEW Jerguson® WF Series Wide Indicator

- Industry best 1.5" (38.10mm) width
- IP68 Rated Hermetically Sealed construction available
- Stainless steel precision stamping
- Permanent ceramic magnet in each flag
- Dual rotation points

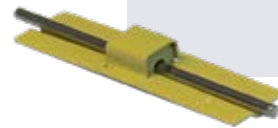

At rest, each flag is strongly attracted to each adjacent flag of the same color, with an active magnetic field of 200 Gauss at the leading edges. This attraction can only be broken by a magnetic field strong enough to cause the flags to rotate (the Magnicator float assembly), making each flag assembly ***extremely shock and vibration resistant.***

Potential Problems with Other Manufacturers' Indicators

Skipped, Missed Flags



Weak magnetic coupling between the flags and float magnetic field can lead to missed flags and unreliable indication. Operator must manually “reset” the flags or wait for the level to cycle.

Other Possible Problems

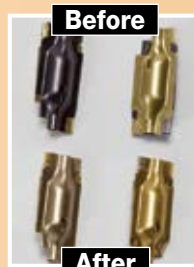

- Flags can fade with exposure to UV light (sunlight) or temperatures over 500°F (260°C)
- Shuttle/Follower indicators prone to weak coupling, dropping.
- Anodized or plastic flags with stickers are prone to change in appearance (or even melt) due to exposure to UV, heat.



Fallen Follower



This style relies on colored stickers applied to plastic flags.

Superior Solutions for Severe Serv

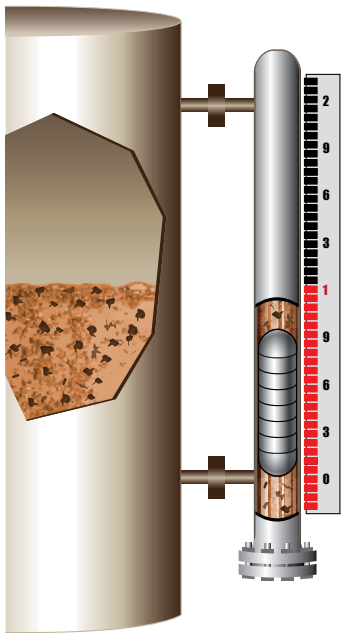

Oversized Chamber Designs for Dirty Service

- Ideal for applications where suspended solids can build up and cause float to become “stuck”
- Oversized chamber with guide rods creates free space for float to move freely without binding against chamber wall
- Free Space allows gage to be flushed without removing float, reducing downtime, and cost of replacing gasket

Note: The indicator orientation must be specified at the time of order placement. Indicators cannot be rotated beyond active magnetic field during installation.



TOP VIEW



Hermetically-Sealed Flag Indicator

- Ideal for Offshore, Corrosive Vapors, Cryogenic and other severe environments
- Permanently sealed!
 - no gaskets or valves; **can't leak or fog**
- Includes 316SS housing and scale
 - dual scale available
- WF Series Wide Indicator Available (Polycarbonate Only)
- Flag indicators are purged with inert gas and permanently sealed in:
 - polycarbonate tubing with epoxy-sealed end plugs to 500°F (260°C) process temperatures; or
 - glass tubing with 100% fused glass end seals to 1000°F (538°C) process temperatures



High Pressure Spherical Floats

for Pressures Up to 3500 PSIG (241 BarG)

This unique spherical float design delivers the same focused magnetic characteristics and reliability as our standard float. The non-pressurized high strength titanium design is safer and more reliable than pressurized versions. Accommodates specific gravity down to 0.36, temperatures up to 1000°F (538°C) and pressures to 3500 PSIG (241 BarG) @ 100°F (37°C). Segmented float design reduces required ground clearance under unit.

Hermetically-Sealed Design

Pressure/Temperature and Min SG Ratings

PSIG (BarG) @ 100°F	PSIG (BarG) @ Max Temp	Max Temp °F (°C)	Min SG (27.5" L)	SG (16.25" L)	SG (11.75" L)
1500 (103)	745 (51)	1000 (538)	0.46	0.61	0.76
3000 (206)	1495 (103)	1000 (538)	0.61	0.78	0.95
3500 (241)	2465 (170)	600 (315)	0.56	0.70	0.83

L = Float Length

Carrier (Open Magnets) Design

Pressure/Temperature and Min SG Ratings

PSIG (BarG) @ 100°F	PSIG (BarG) @ Max Temp	Max Temp °F (°C)	Min SG (27.3" L)	SG (16" L)	SG (11.5" L)
1500 (103)	1330 (92)	250 (121)	0.36	0.43	0.52
3500 (241)	3105 (214)	250 (121)	0.61	0.59	0.69

L = Float Length

Contact Factory for Pressure/Temperature rating beyond those listed in this table.

Hermetically-sealed design. Float lengths of up to 27" can be provided for low specific gravity applications.



Carrier style available for low temperature, non-acidic applications - Contact Factory for more information.



Superior Solutions for Boiling Fluids

Magnicator® Flashproof™ Products

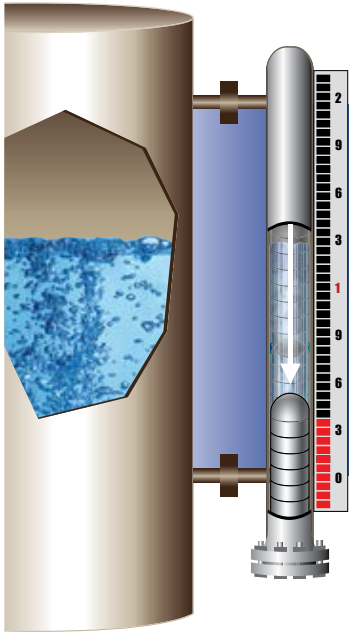

Boiling Fluids

Boiling fluids can cause the float to sink in a traditional level indicator. This situation is common when there are substantial temperature differences between the fluid in a vessel and the fluid in an indicator chamber (Think: cold liquid in vessel; hot summer day for indicator.)

The Jerguson® FlashProof™ design addresses two potential problems that may occur with standard level indicators: boiling fluids and flashing vapors. By employing a larger (3") Schedule 40 pipe with two internal guide rods, entrained gases that build up under the float can harmlessly escape. The float is held to one side of the chamber to ensure an optimized magnetic field in close proximity to the indicator, transmitter or switches. This provides an accurate float level and indicator reading.

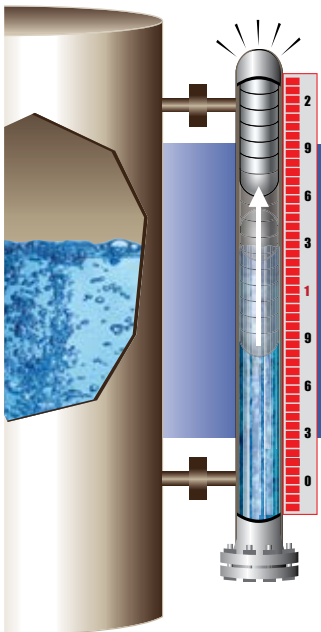

Flashing Vapors

Flashing vapors can cause a float to accelerate upwards rapidly, crashing into the top of the chamber due to depressurization.

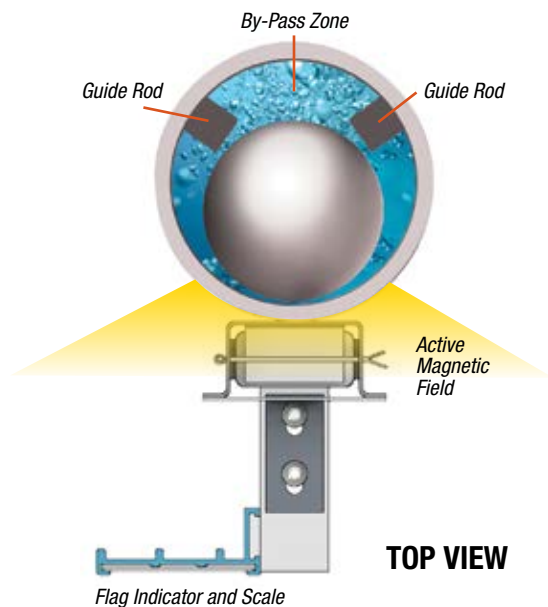

Note: The indicator orientation must be specified at the time of order placement. Indicator cannot be rotated beyond active magnetic field during placement.

Watch the video at:
www.jerguson.com/flashproof/

Indicators or Flashing Vapors

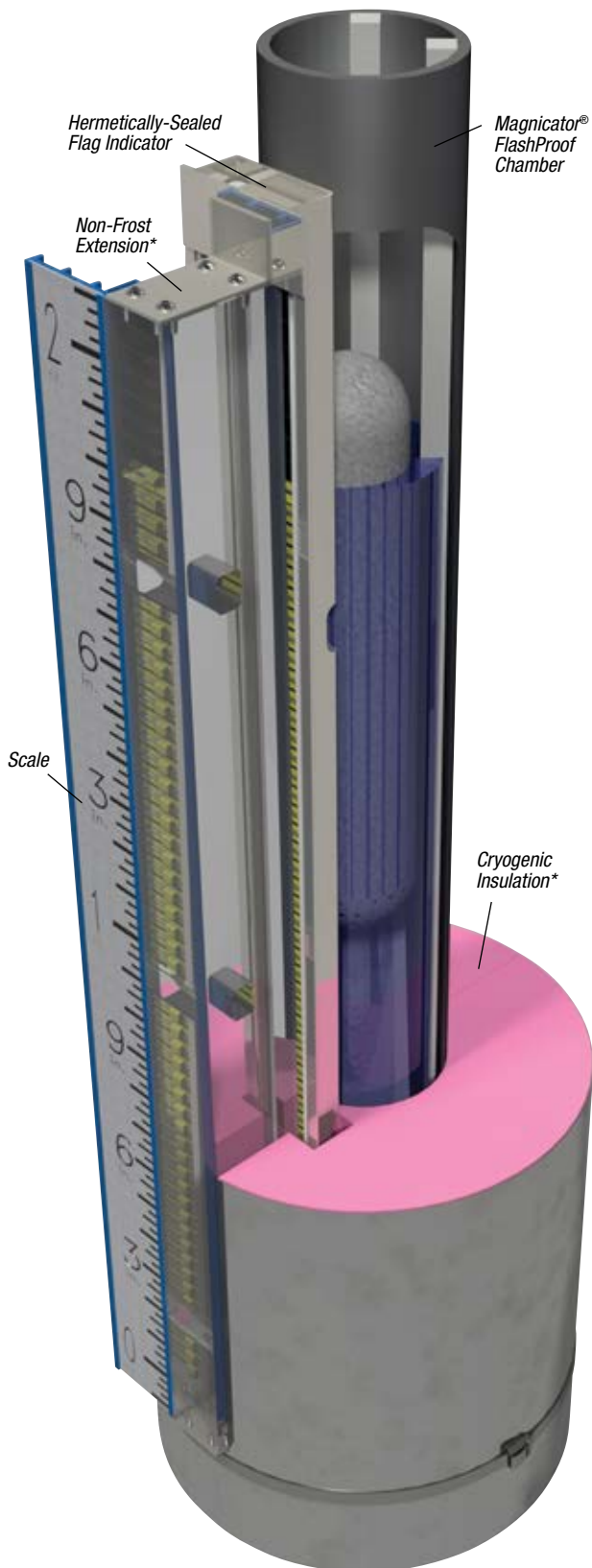

Specification Overview

- Larger diameter chamber with float guides
- Complies to ASME B31.1 and ASME B31.3
- Available with full range of Jerguson indicators, transmitters and switches
- 3" Schedule 40 pipe chamber as standard
- Schedule 80 and 120 available for high pressure applications
- Size Range from 12" to 240" (305mm to 6096mm) vessel centers (Consult factory for longer units)
- Specific gravity minimum: 0.36
- Pressure class rating up to 1919 PSIG (132 BarG) @ 100°F (37°C) as per ASME B31.3 (Higher pressures are available)
- Temperature Range: -325°F to 1000°F (-198°C to 538°C)

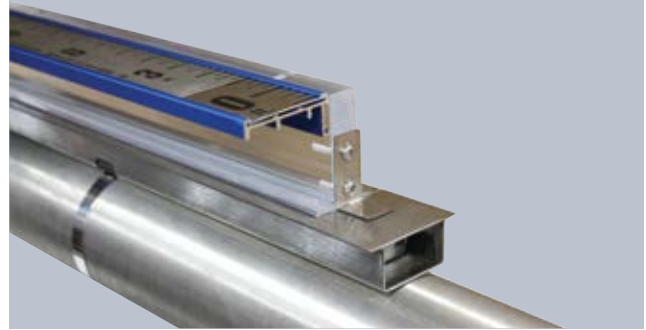

Common Applications

- | | |
|-----------------------------------|--|
| • Ethane | • Methane |
| • Liquid Nitrogen | • Carbon Dioxide |
| • Propane | • Anhydrous Ammonia and other refrigerants |
| • Butane | • LPG |
| • Propylene | • LNG |
| • Cryogenic | • Light End Hydrocarbons |
| • Ethylene | • Other "Dirty" Service (See page 6) |
| • Atmospheric Distillation Towers | |

* Recommended when design temperature is below 32°F (0°C).

Superior Solutions for Low Light

NightStar® LED Illuminators

Here's a Really Bright Idea

NightStar® Indicators for the Magnicator® make a level indicator continuously visible... night or day with bright LED illumination.

No more flashlight searches, no more spending more time than needed in process areas.

NightStar Illuminators provide an array of bright LEDs to shine on standard mechanical flag indicators. No light or low-light, the operator can easily and reliably verify level.

- High contrast indication
- Not angle dependent – viewer can see clearly from many positions
- Reduced operator exposure in process areas can increase safety
- LEDs have a nominal life of 10 years
- Approved for use in Class I, Div. 1 classified locations
- FL Series Standard Flag

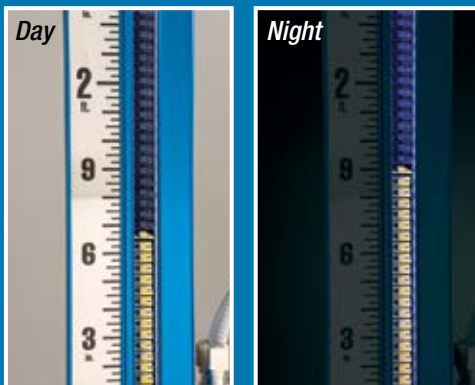

NightStar LED base illuminator for the Magnicator®



ight Conditions

An Easy Upgrade for Any Magnetic Level Indicator



NightStar® Indicators can be field-upgraded on any Jerguson® magnetic indicator, or other manufacturer's indicator, by replacing both the float and indicator.



NightStar® Indicator

Specification Overview



- Class I, Div. 1 and 2 Groups B,C,D T4
- Class I, Zone 1 and 2 AEx db [ib] IIB+H2 T4 Gb (Power Supply)
- Class I, Zone 1 and 2 AEx ib IIB+H2 T4 Gb (Light)
- Ex db [ib] IIB+H2 T4 Gb (Power Supply)
- Ex ib IIB+H2 T4 Gb (Light)
- $-40^{\circ}\text{C} (-40^{\circ}\text{F}) \leq T_a \leq 60^{\circ}\text{C} (140^{\circ}\text{F})$



- Ex db [ib] IIB+H2 T4 Gb (Power Supply)
- Ex ib IIB+H2 T4 Gb (Light)
- $-40^{\circ}\text{C} (-40^{\circ}\text{F}) \leq T_a \leq 60^{\circ}\text{C} (140^{\circ}\text{F})$



- II 2 G Ex db [ib] IIB+H2 T4 Gb (Power Supply)
- II 2 G Ex ib IIB+H2 T4 Gb (Light)
- $-40^{\circ}\text{C} (-40^{\circ}\text{F}) \leq T_a \leq 60^{\circ}\text{C} (140^{\circ}\text{F})$

- Power Supply:
120 or 240 VAC
- Power Consumption:
< 250 mA @ 115 VAC
< 125 mA @ 230 VAC
- Max. Remote Distance from Power Supply to Light Strip = *~72 feet (22m)*
- Electrical Connection: *3/4" FNPT*
- Process Temperature:
 - *Up to 450°F (232°C)*
 - *450°F (232°C) to 600°F (316°C) with air purge kit on indicator*
- Protection Methods:
 - *Explosion-proof power supply*
 - *Intrinsically-safe lighting circuit*
 - *NEMA 4X design*

“Not only have the Jerguson magnetic indicators become the standard for our FCCU in Marcus Hook, but our operators specifically request the NightStar on all models we install.”

– **Beth Lavine,**
Project Specialist
Philadelphia Area Refinery

JMT™ Series



Magnetostrictive Transmitter

The JMT™ Series magnetostrictive transmitter is a cosmic leap forward in features and versatility. Utilizing Jerguson's patent pending signal capture technology, the JMT features unsurpassed signal to noise ratio. When installed with the Jerguson Magnicator®'s unique magnetic field, the JMT can be mounted on almost any chamber combination, including Schedule 160, without sacrificing reliability. The dual-entry enclosure allows for safe access to the HMI where information can be had with a touch of the button including current level information, settings, and a LIVE graph showing you the real-time waveform. The JMT is designed to work and be fully configurable with generic HART. Every aspect of the JMT has been developed for ease of installation, setup, and connectivity. Just like our wide range of reliable flag indicators, floats, and switches, the JMT adds continuous level control you can trust from Jerguson.

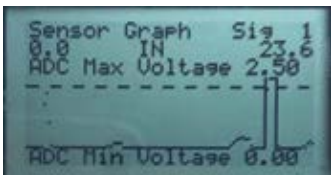

- View Full waveform, including trigger level and # of peaks
- LIVE View of signal, noise condition

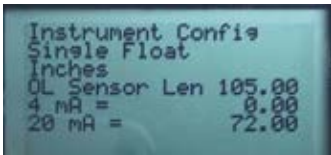

- Quickly Display Current Device Parameters
- Verify Range, URV, LRV
- Verify SN, Tag#

- 4-20 mA loop powered; 12.5 to 36 VDC
- HART Protocol Communication Standard (HART 7 EDDL Pending)
- Sensing lengths from 12 inches (305mm) to 360 inches (9 meters)
- Process Temperature -300°F to 700°F (-185°C to 372°C) (Insulation Safeguards Required over 350°F [176°C])
- Dual Float Functionality (Interface and Total Level)
- ETL approved for USA, Canada, ATEX and IECEx (Explosion/Flame Proof, Intrinsic Safety)
- Dual Compartment NEMA 4X; IP66 Enclosure
 - Epoxy Coated Aluminum Standard
 - 316SS optional
- One-Touch Waveform Graphical Display

Hazardous Area Certifications

Explosion Proof



ETL (USA, Canada)

- Class I, Div. 1 and 2, Groups B, C, D; T6
- Class I, Zone 1, AEx db IIB+H2 T6 Ex db IIB+H2 T6 Gb
- -40°C ≤ Ta ≤ +60°C (-40°F ≤ Ta ≤ +140°F)



ATEX

- II 2 G Ex db IIB+H2 T6 Gb
- -40°C ≤ Ta ≤ +60°C (-40°F ≤ Ta ≤ +140°F)



IECEx

- Ex db IIB+H2 T6 Gb
- -40°C to +60°C (-40°F to +140°F)

Intrinsic Safety

ETL (USA, Canada)

- Class I, Div. 1 and 2, Groups C, D, T4
- Class I, Zone 1, AEx db ia IIB T4 GB Ex db ia IIB T4 Gb
- -40°C ≤ Ta ≤ +60°C (-40°F ≤ Ta ≤ +140°F)

ATEX

- II 2 G Ex db ia IIB T4 Gb
- -40°C ≤ Ta ≤ +60°C (-40°F ≤ Ta ≤ +140°F)

IECEx

- Ex db ia IIB T4 Gb
- -40°C ≤ Ta ≤ +60°C (-40°F ≤ Ta ≤ +140°F)

How to Specify JMT Magnetostrictive Transmitter

JMT G - A2 A - 04800 - S S 1

Mounting Style

Code Description

G Gage Mount
- 316L/316SS Sensor Housing

Housing

Code Description

A2 Aluminum Dual Compartment
S2 Stainless Steel Dual Compartment

Transmitter Orientation

Code Description

A Top Left Hand (Standard)
B Top Right Hand
C Bottom Right Hand
D Bottom Left Hand

Measuring Range

Order Length: 12" to 360" (305mm to 9144mm)
On 1-Inch Increments, in Hundredths of an Inch (Example: 48" = 04800)

Process Temperature (A-Z)

Code Description

S Standard
H High Temperature (Insulation Blanket Required for Processes over 350°F [176°C])
C Cold Temperature (Thermowell Included - Insulation Safeguards Required)
V Vibration (Special Mounting)

Safety Integrity Level

Code Description

Null None

Remote Mount

Code Description

Null Standard

Area Classification

Code Description

0 Ordinary Location (IP66/Type 4X)
1 North American Explosion Proof/Flame Proof (IP66/Type 4X)
2 North American Intrinsic Safety (IP66/Type 4X)
3 ATEX / IECEx Flame Proof (IP66/Type 4X)
4 ATEX / IECEx Intrinsic Safety (IP66/Type 4X)

Level

Code Description

S Single Level
D Dual Level

Specifications

Electronics

Supply Voltage: 12.5 - 36 Vdc (12.5 V @ 20mA)

Repeatability: .005% of full scale or .010", whichever is greater

Non-Linearity: .01% of full scale or .030", whichever is greater

Damping: 1 to 32 Seconds

Operating Temp: -50°C to 85°C (-58°F to 185°F)

RFI Guide: SAMA PMC 31.1-5.1
20 to 1000 Mhz to 30 V/m

Humidity Guide: SAMA PMC 31.1-5.2

Housing

- Dual compartment explosion proof housing
- 3/4" NPT conduit entry
- Epoxy coated aluminum (Standard); 316SS (Optional)
- Nema 4X; IP66

Sensor Probe Specification

Gage Mount Material: 316L/316SS Standard

Vibration Guide: SAMA PMC 31.1-5.3

See Sales Drawing A-35152-SALES for BOM and Dimensional Information

Magnicator® Gage with Guided Wave Radar

Redundant Sensing Technologies for the Ultimate in Reliable Level Indication

By combining guided wave radar (GWR) with a magnetic level gage, the Magnicator® Guided Wave Radar (MGWR) brings a new standard of assurance to level indication. **The MGWR is ideal for high-pressure steam and offshore production where product densities vary.**

The primary advantage of a guided wave radar (GWR) transmitter over a Magnetostrictive or Reed Switch transmitter is that the GWR transmitter is an independent device that does not rely on the float's magnetic field to obtain a reading.

The GWR transmitter obtains an independent reading of the liquid level, providing an accurate output even in the case of a float failure. Also, the GWR transmitter will read the true level of the fluid, even if the density of the product varies.



Guided Wave Radar
Changes in product specific gravity do not affect output.

Transmitter Features

- Measurement independent of density, conductivity, dielectric constant and temperature
- Measurement unaffected by foam or turbulent surfaces
- Process temperatures from -328°F (-200°C) to 842°F (450°C)
- Pressure ranges from full vacuum up to 3500 PSIG (240 BarG) for MGWR or 5802 PSIG (400 BarG) for GWR chamber alone
- Models available for interface applications; both total and interface level can be provided on one HART® signal
- Models available with gas phase compensation for steam applications
- Communication Protocols
 - 4-20 mA SIL HART®
 - Fieldbus Foundation™ (no local display)

Alternate Arrangements

- Process Connections off GWR chamber
- Isolation valves between chambers
- FlashProof™ MLI Chamber
- Flushing Ports on GWR or MLI chamber
- Flanged bottom GWR Chamber



Switches and Transmitters

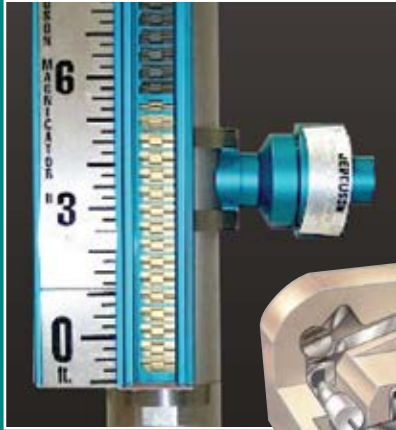

Cutaway view

SAS-16™ Tri-Magnet Latching Switch

Unique design creates a snap action switch strictly through the use of repelling magnetic fields.

- No cams or springs
- Highly vibration-resistant
- SPDT Switch
 - Max (AC); 300 VAC, 10A
 - Max Power (AC); 2000VA
 - Max (DC); 240 VDC, 10A
 - Max Power (DC) 50W
- 750°F (399°C) Max Process Temperature
- UL approved for hazardous locations Class I, Div. 1, Grps. A, B, C, & D
- Ex db IIC T6...T1 Gb
-20°C (-4°F) ≤ Ta ≤ 60°C (140°F)
- II 2 G Ex db IIC T6...T1 Gb
-20°C (-4°F) ≤ Ta ≤ 60°C (140°F)
- NEMA 4X design
- Easy installation – externally clamps to gage chamber
- Anodized Aluminum Housing (Standard)
316/316LSS Housing (Optional, UL Approval only)
- Available with integral terminal block enclosure



MTII-4300™ Magnetostrictive Transmitter

- 4-20 mA loop-powered; 10.5 to 28 VDC
- HART 7 protocol standard
- SIL2 Available
- Foundation Fieldbus output available (MTII-4200 - no local display)
- Sensing lengths from 6 inches to 228 inches (15 cm to 6 meters)
- Continuous level measurement with repeatability .01% Full Scale
- FM & CSA - Class I, Div. 1 Grps. B, C, & D
- ATEX II 1/2G Ex ia IIC/ T4 Ta = -50°F to 71°C (XP Available - contact factory)
- NEMA 4X design



RST2™ - Reed Switch Transmitter

- 4-20 mA loop-powered transmitter
- 1/2" resolution
- UL/CUL Class I, Div. 1 Grps. B, C, & D
- NEMA 4X design
- Field Adjustable Span
- Hermetically Sealed version available



RS-2™ or RS-2/2™ Hermetically-Sealed Reed Switch

- Low power switches for DCS and starter circuits
- SPDT and DPDT switch configuration
- 120 Maximum VAC; 1 Amp Maximum; 30 Watts Maximum (Volt X Amps = Watts)
- UL/CUL listed Class I, Div. 1 Grps. B, C, & D
- NEMA 4X design

**Pneumatic Switches available;
visit www.jerguson.com**

Guidelines for Code-Compliant Use of Magnetic Level Indicators (MLI) on Boilers

ASME Section I Applications

Figures 1a & 1b represent typical installations of a Magnetic Level Indicator (MLI) attached to a water column, which is attached to the boiler drum (5). Note the following:

- The line for the steam connection from the drum to the water column (1) should slope downward from the drum.
- The line for the water connection from the drum to the water column (2) should be level or slope upward from the drum to the water column.
- Refer to Section I Code for requirements on the number and type of isolation valves.

The following application notes must be followed for Code Compliance:

- A Magnetic Level Indicator (MLI) can only be used up to 900# WSP (Working Steam Pressure) [Section I, Subsection PG-12.2]
- The indicator & scale must start (4) above the highest point of the water connection (2) and end (6) below the lowest point of the steam connection (7) (see Figure 1)
- Lowest indication (4) must be at least 2" above the lowest safe operating level (3) as determined by the boiler manufacturer (typically found on boiler drawing)
- MLIs are classified as indirect remote water level indicators
- MLIs must NOT replace a code required direct-reading glass level gage
- "Attachment of control devices for use other than indicating water level is prohibited" [Section I, Subsection PG-60.1.1.3]

Contact a Jerguson® Application Engineer for support

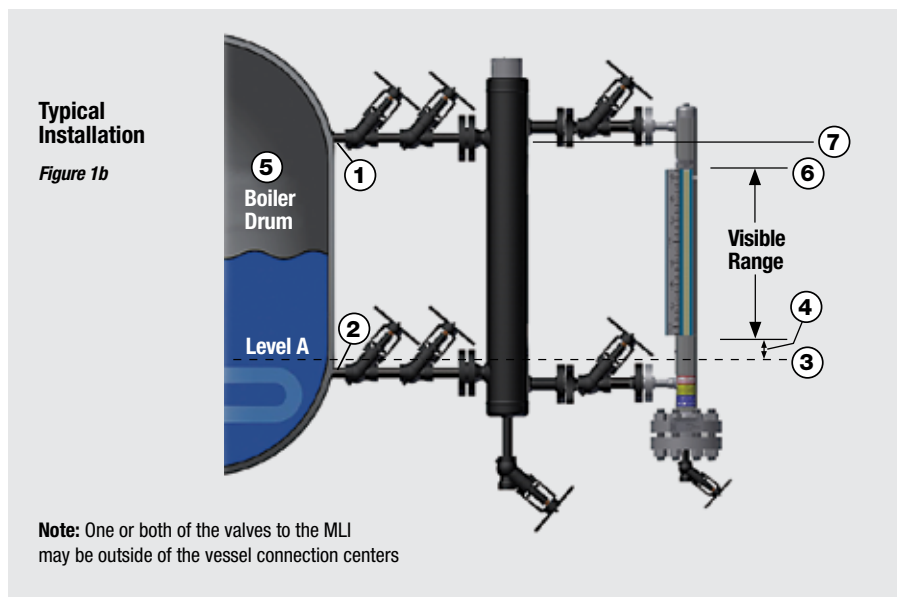
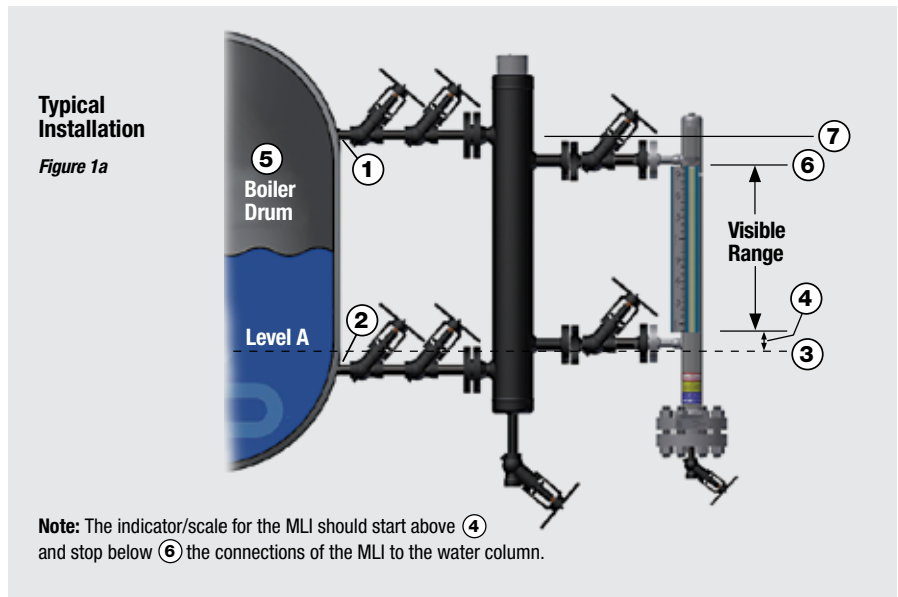

Options & Accessories



Non-Frost Extension

- 2-1/2" acrylic (standard)
- Available on Wide Indicator
- Custom sizes available



Hot or Cold Insulation

Hot Insulation To 500°F (260°C)

Jacket covers entire gage and includes drawcords at each end for closure. Provided with openings for gage process connections, indicator and switches or transmitters.

- PTFE coated & impregnated fiberglass
- 1" thickness to 500°F (260°C)
- Stainless steel grommets
- Polypropylene / fiberglass drawcord at ends
- Contact factory for higher temperatures



Cryogenic Insulation 32°F (0°C) to -250°F (-156°C)

- Polyisocyanurate foam insulation - 2" thick
- .016" aluminum jacketing with moisture barrier
- All joints sealed
- Optional non-frost extension required

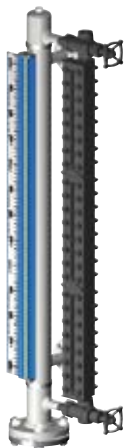

Combination Sight Glass / Magnetic Level Indicator

- Use glass level gage for calibration and level verification only
- Maintenance is virtually eliminated
- Available as an upgrade for sight glass installations
- Not for use in ASME Section I Installations

Jerguson® Mini-Magnicator™

- Economical magnetic gage features single bar magnet float
- Pressures to 400 PSIG (27 BarG)
- Temperatures to 500°F (260°C)
- Specific gravity 0.7 or greater
- Local indication only
- See M100.130 for more information



Electric Heat Trace

- Class II Standard
- Optional Class I, Div. 1
- Thermostat available
- Two (2) passes standard installation



Steam Heat Trace

- 3/8" compression fitting both ends
- Four (4) passes standard installation



Magnetic Particle Trap

- Prevent build-up of ferritic material around float magnets
- SW Tee (std.) in lower process connection with 1/2" NPT plug and magnet
- Plug/Magnet removable when isolated for cleaning, replacement

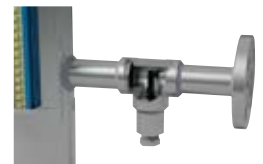

Magnicator® Model Code

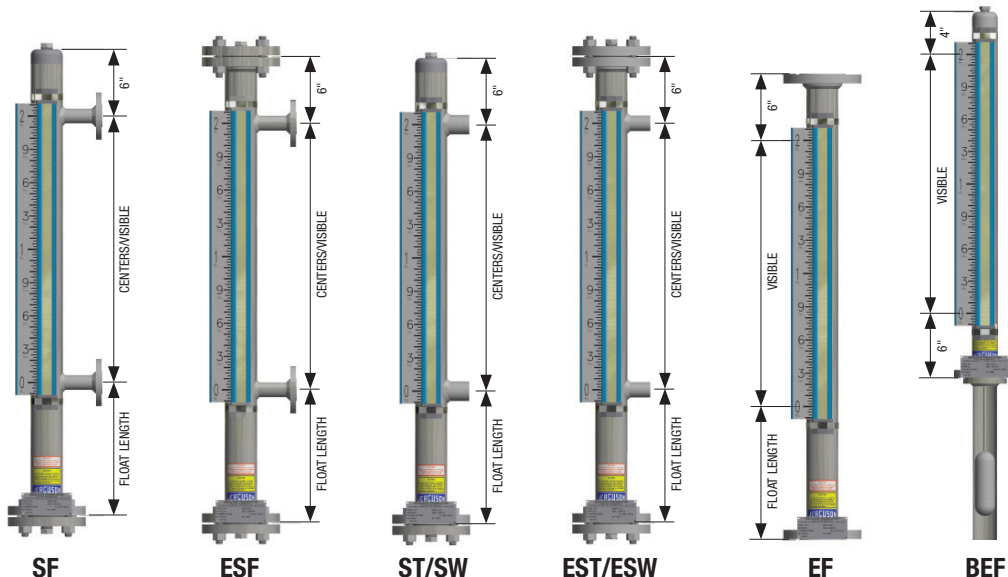
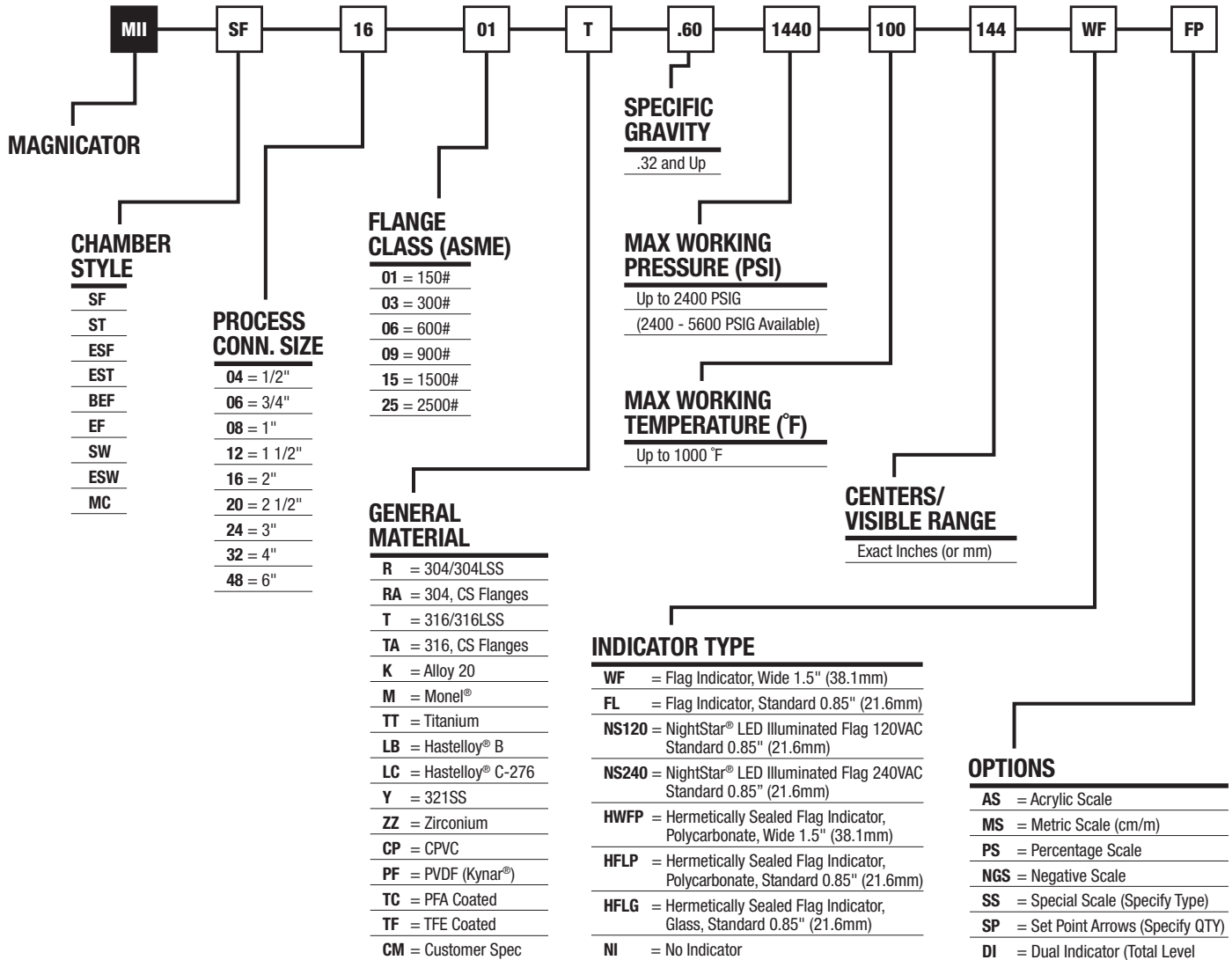

* Not available on FL, NS120/240

Contact factory for MC style gages.

Magnicator® Level Products

Specifications

Column Construction

- Complies with ASME B31.1 (Power Piping) and B31.3 (Process Piping) design requirements
- NACE MR0103/0175
- ASME Section VIII U Stamp Available
- PED Available
- Conforms to European Directive 2014/34/EU for mechanical equipment in potentially explosive areas
- CRN Approved for all Provinces/Territories
- Welding in accordance with ASME Section IX
- 100% Hydrostatic testing to 1.5x the column rating (typically limited by flange rating)
- 2-1/2" Sch 40 standard, options for 2-1/2" Sch 80 or 3" Sch 160
 - 3" Sch 40 standard with FlashProof Chamber (See pages 8-9)
 - Sch 10 utilized for PFA Coated Gages Only

Materials of Construction - Column

- Austenitic Stainless Steel Grades 304/304L, 316/316L, 317, 321, 347
- Alloy 20, Hastelloy® C-276, Hastelloy® B3, Monel®, Titanium, Inconel® 625/825, Zirconium, AL-6XN®, SMO254®
- Other non-ferrous alloys
- CPVC, PVDF (Kynar®)
- PFA Teflon or Kynar® Coated Options Available (All flanged connections required)

Pressure Range

- Full vacuum to 3500 PSIG (241 BarG)
 - Consult Factory for higher pressure applications

Temperature Range

- -325°F (-198°C) to 1000°F (538°C)

Measurement Range

- 12" (305mm) to 240" (6096mm) Standard
- Lengths up to 60 feet (18m) available; consult factory

Specific Gravity

- 0.32 Minimum

Float Construction

- Pressures up to 3500 PSIG (241 BarG) with Sealed Float
- Permanent magnet arrangement of Alnico 8 or higher energy level
- 316L Stainless Steel, Titanium, Monel®, Hastelloy® C-276 or Alloy-20
- Autogenous welding
- Magnetic field strength of 90 Gauss at flag indicator

Visual Indicators

- Yellow/Black bi-color anti-vibration flag standard (Red/White available with "standard option")
- Industry best 1.5" (38.10mm) width available (WF Series)
- Optional NightStar® white LED Illuminated standard flag
- Hermetically sealed flag indicator in 316SS housing suitable for offshore environments
 - IP68 Rated Hermetically Sealed construction available
 - Polycarbonate tubing with epoxy-sealed end plugs to 500°F (260°C) process temperatures (WF and FL Series)
 - Glass tubing with 100% fused glass end seals to 1000°F (538°C) process temperatures (FL Series Only)

Indicator Flag Construction

- Stainless steel indicator flag and rotation pin
- Individual permanent magnet in each indicator flag
 - WF Series 1.5" (38.1mm) Width
 - FL Series 0.85" (21.6mm) Width

Indicator Housing Construction

- Anodized aluminum or 316SS indicator housing with 316SS photo-etched scale
 - Inches/feet – Negative values
 - Centimeters/meters – Custom
 - Percentage

Switch Options

- Magnetic snap-action
 - SAS-16: SPDT
 - Max (AC); 300 VAC, 10A
 - Max Power (AC); 2000VA
 - Max (DC); 240 VDC, 10A,
 - Max Power (DC) 50W
- Reed element
 - RS-2: SPDT 1A, 120 VAC, 30W
 - RS-2/2: DPDT 1A, 120 VAC, 30W

Transmitter Options

- JMT Magnetostrictive Transmitter MTII-4300, MTII-4200
- Guided Wave Radar
- RST2 reed switch elements (1/2" resolution)

Temperature Maintenance

- Steam or Electric Tracing
- Steam Jacket

Insulation

- Cryogenic with non-frost acrylic extension down to -250°F (-156°C)
- High Temperature removable jacket up to 500°F (260°C)

MORE **Jerguson**® SOLUTIONS



Jerguson®
360™ Valve



Jerguson® Tri-Magnet™
Level Switches



Jerguson® SafeView™
Safety & Protection



Jerguson® LumaStar™
Level Gage Illuminators

Authorised Distributor:



46, Jalan SS 22/21, Damansara Jaya,
47400 Petaling Jaya,
Selangor Darul Ehsan, Malaysia.

Email: nog@nog.com.my
Webste: www.nog.com.my

JERGUSON®
A PRODUCT OF CLARK-RELIANCE



ISO 9001:2000