

1800B2 and 1800B2-HC Series Service Regulators

Technical Bulletin



The 1800B2 Series pressure regulators are designed to control natural gas, air, nitrogen, carbon dioxide, propane vapor, and other non-corrosive gases in residential, light commercial, and small industrial applications.

General Information

Outlet pressures between 3.5" W.C. and 2 PSIG are available. Operating temperature range is -20°F to 150°F (-30°C to 65°C). Maximum flow rate is 2500 SCFH (70.8 m³/h).

All models conform to ANSI Code B109.4-1998, and CGA Service-Type Regulator Specification CAN/CGA-6.18-M95.

Features

- Variety of interchangeable orifices and spring ranges
- 90 Degree (Right Angle), 180 Degree (Straight-Flow), or Offset Valve Body (See photo on next page)
- Wide range of valve body connection sizes

Options

Vent Elbow

The regulator vent opening should face downward (6 o'clock) to minimize the chance of blockage from ice and snow. If not possible, a 3/4" NPT plastic, 90° vent elbow (part number 78041P025) and separate protective screen (part number 70400P017) may be screwed into the vent to provide the necessary protection.

Elevation Compensation

The E.C. orifice is recommended for installations where the inlet pressure may vary over a wide range. The E.C. orifice is available in two sizes: 1/8" x 3/16" and 3/16". The capacities of these orifices are the same as the standard orifice of the same size.

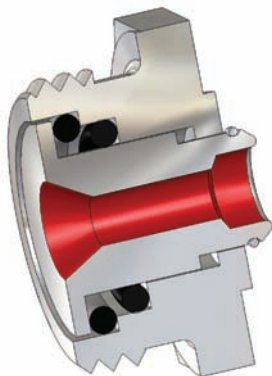

Applications

Model Number	Description
1803B2	Basic regulator, non-relieving with 3/4" or 1" NPT vent.
1803B2-HC	Basic regulator, non-relieving with 3/4" or 1" NPT vent.
1813B2	Basic regulator with full-capacity internal relief with 3/4" or 1" NPT vent.
1813B2-HC	Basic regulator with full-capacity internal relief with 3/4" or 1" NPT vent.
1823B2	Basic regulator, non-relieving with under-pressure shut-off and 3/4" or 1" NPT vent.
1833B2	Basic regulator with full-capacity internal relief and underpressure shut-off and 3/4" or 1" NPT vent.
1843B2	Basic regulator with full-capacity internal relief and overpressure shut-off and 3/4" or 1" NPT vent.
1843B2-HC	Basic regulator with full-capacity internal relief and overpressure shut-off and 3/4" or 1" NPT vent.
1843B2-L	Basic regulator with limited relief and overpressure shut-off and 3/4" or 1" NPT vent.
1853B2	Basic regulator with full-capacity internal relief and overpressure, underpressure shut-off and 3/4" or 1" NPT vent.
1883B2	Basic regulator, non-relieving with overpressure shut-off and 3/4" or 1" NPT vent.
1883B2-HC	Basic regulator, non-relieving with overpressure shut-off and 3/4" or 1" NPT vent.
1893B2	Basic regulator, non-relieving with overpressure, underpressure shut-off and 3/4" or 1" NPT vent.
1853B2 w/USSA	Basic regulator with full-capacity internal relief and overpressure, underpressure shut-off and 3/4" or 1" NPT vent.
1853B2-HC w/USSA	Basic regulator with full-capacity internal relief and overpressure, underpressure shut-off and 3/4" or 1" NPT vent.
1893B2 w/USSA	Basic regulator, non-relieving with overpressure, underpressure shut-off and 3/4" or 1" NPT vent.
1893B2-HC w/USSA	Basic regulator, non-relieving with overpressure, underpressure shut-off and 3/4" or 1" NPT vent.

Full Capacity Relief Valve

Full capacity relief valve standard on some models. (See Performance Graphs on page 10)

Splashguards

UV stabilized, weather-resistant, resin device that protects the vent screen from splashes while providing a large external vent opening to keep regulators working properly.

Safety Shutoff Devices

Overpressure Shutoff (OPSO) — Operates independently. The OPSO will shut off the gas supply in the event of a serious downstream pressure build-up. These are available in two pressure ranges on the Models 1843B2, 1843B2-HC, 1843B-L, 1853B2, 1883B2, 1883B2-HC, and 1893B2.

Spring Range	Part Number
14" W.C. to 35" W.C.	71403P005
1 PSIG to 3 1/2 PSIG	71403P004

When the outlet pressure exceeds the OPSO set point, the pressure under the OPSO diaphragm plate (A) compresses the pressure spring (B) forcing the diaphragm stem (E) upwards and releasing plunger (D). This permits the shut-off spring (F) to force the shut-off disc (G) against the back side of the special double-ended orifice.

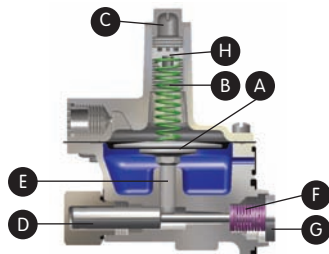

- A** OPSO Diaphragm Plate **B** Pressure Spring
- C** Cap **D** Plunger
- E** Diaphragm Stem **F** Shut-off Spring
- G** Shut-off Disc **H** Adjusting Screw

Underpressure Shutoff (UPS) —
The 1823B2, 1833B2, 1853B2, and the 1893B2 regulators come equipped with an underpressure shutoff (UPS) device which utilizes a spring loaded valve stem and o-ring assembly within an orifice body. It will shut off gas flow through the regulator in the event of an upstream underpressure condition.

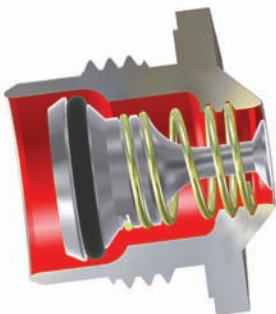

UPS in the Open position

Under normal operating conditions, gas flows through the orifice from the high pressure upstream to the low pressure downstream. If conditions should change to cause the upstream pressure to decrease, the plunger and seat disk assembly will move away from the orifice thereby opening up the regulator to compensate for the lower inlet pressure. The spring in the Underpressure Shutoff will push the valve stem assembly up against the face of the seat disk. Eventually the valve stem's o-ring will make contact with the inner wall of the orifice and completely shut off the gas flow.

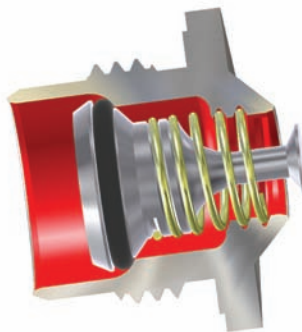

UPS in the Closed position

When the inlet underpressure condition has been corrected or repaired, the UPS must be manually reset to allow gas flow. Reset is done by unscrewing the seal plug and pulling up on the diaphragm stem. This will open the Underpressure Shutoff and allow gas to flow.

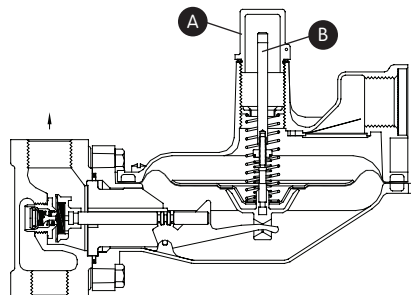

- A** Seal Plug
- B** Diaphragm Stem

This type of design allows service maintenance to be performed to downstream appliances before pressure is introduced, i.e. lighting the pilot light, closing valves, etc. In some cases downstream failure may result in the regulator shutting off. Excessive flow may result in a decrease in downstream pressure which opens the seat disk away from the orifice until the Underpressure Shutoff takes over and shuts the regulator off.

The design has been tested and meets capacity requirements, while insuring efficient and reliable resetting operation even at sub-zero temperatures.

Capacities of the Underpressure Shutoff orifice:

- Set Point: 7" W.C.
- Inlet Pressure: 20 PSIG
- Set at 50 cubic feet per hour
- Maximum inlet pressure rating of 60 PSIG
- Applicable to 3/4", 1", and 1 1/4" valve bodies

Inlet Pressure (PSIG)	Flow Rate (SCFH)
3	300
5	400
10	600
15	750
20	900
30	1000
40	1300
60	1500

Universal Safety Shutoff Assembly (USSA) — USSA protects the downstream piping from both over- and under-pressure conditions by shutting off the gas flow at the inlet side of the regulator orifice. Both Over- and under-pressure shut-off set points are adjustable.

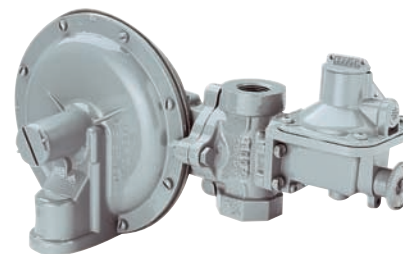

USSA Shutoff Spring Ranges
Over Pressure Spring Ranges

Spring Range	Part Number
7.5 - 24" W.C.	70017P123
20 - 32" W.C.	70017P124
24 - 44" W.C.	70017P125
40 - 84" W.C.	70017P126
3 - 5 PSIG	70017P127
4 - 7 PSIG	70017P128

Under Pressure Spring Ranges

Spring Range	Part Number
3 - 6" W.C.	70017P133
6 - 24" W.C.	70017P134
24 - 60" W.C.	70017P135

Pressure Taps

1/8" NPT taps are available on most valve heads.

Offset Valve Body



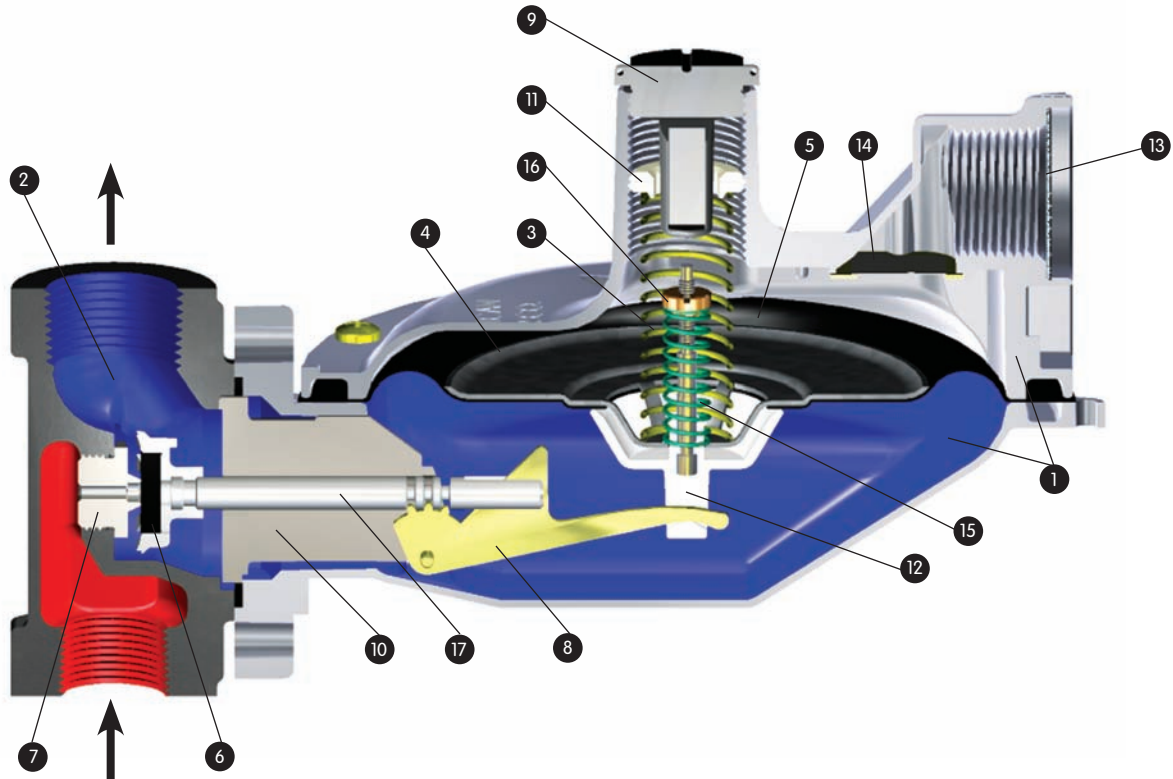

Material Specifications

- 1 Diaphragm Case - Precision die-cast aluminum with an exclusive seven-step advanced conversion coating, single-coat polyester primer and high solids polyurethane top coat.
- 2 Valve Body - Cast grey iron, undercoated, single coat polyester primer and high solids polyurethane top coat. NPT threads meet ANSI/ASME B1.20.1.
- 3 Pressure Spring - Steel, zinc plated and yellow chromate. Color coded for identification.
- 4 Diaphragm Plate - Steel, Electrogalvanized.
- 5 Diaphragm - Nylon fabric reinforced Buna N.
- 6 Seat Disc - Buna N; 60, 70 (std.) or 80 durometer rating.
- 7 Orifice Valve - High strength, corrosion resistant aluminum.

Available sizes: 3/4" x 3/4", 3/4" x 1", 3/4" x 1-1/4", 1" x 1", 1" x 1-1/4" and 1-1/4" x 1-1/4" NPT or BSP-TR

Offset valve body: 3/4" x 3/4", 3/4" x 1" and 1" x 1" NPT or BSP-TR

Outlet Pressure	Color Code	Part Number
3.5" to 6" W.C.	Blue	70017P043
3.5" to 7.5" W.C.	Tan	70017P089
5.5" to 8.5" W.C.	Yellow	70017P044
6" to 12" W.C.	Brown	70017P137
6" to 15" W.C.	Purple	70017P042
12" to 28" W.C.	White	70017P060
24" to 48" W.C.	Red	70017P082
42" W.C. to 2 PSIG	Red - Red	70017P049

Orifice Size	Standard Part Number	Part Number with OPSO
9/16"	72494P026	72751P019
1/2"	72494P025	72751P016
3/8"	72494P023	72751P014
5/16"	72494P022	72751P013
OPSO	71422G004	71422G004
1/4"	72494P021	72751P012
3/16"	72494P020	72751P011
1/8" x 3/16"	72494P030	72751P020
1/8"	72494P019	N/A

- 8 Lever - Steel, zinc plated and yellow chromate.
- 9 Seal Plug - Minlon.
- 10 Plunger Guide - Minlon.
- 11 Pressure Adjustment Screw - Minlon.

- 12 Relief Valve Stem - Celcon with steel, zinc plated and yellow chromate insert.
- 13 Vent Screen - Stainless Steel - All models are designed with a removable weather and bug-proof stainless steel screen to resist freeze-ups and to exclude foreign matter. The vent is threaded 3/4" or 1" NPT (BSP-TR threads available). A vent line can be added to carry gas away to a safe outside location and away from any opening(s) in the building. Comply with applicable Federal, State, and local codes.
- 14 Vent Valve - Stainless Steel with Electrogalvanized steel retainer.
- 15 Relief Valve Spring - Steel, zinc plated and yellow chromate. Adjustable. Color coded for identification. Standard set point of 8" W.C. above outlet set pressure of 7" W.C. Standard set point of 1.1 PSIG above outlet set pressure of 2 PSIG.
- 16 Relief Valve Adjustment Nut - Brass, sintered.

1800B2 Regulator Capacity Performance

3/4" Outlet Set Point 7.0" W.C. at 50 SCFH

SCFH (m³/h) 0.60 specific gravity gas at 60°F and 14.7 PSIA. Pressure spring 70017P044. Outlet pressure variance not to exceed +2" -1" W.C. from set point, horizontal position.

1800B2 Series Regulator Capacity SCFH (m³/h)

Inlet PSIG (bar)	1/8" x 3/16" Orifice	3/16" Orifice	1/4" Orifice	5/16" Orifice	3/8" Orifice	1/2" Orifice	9/16" Orifice
1 (0.07)	—	150 (4.2)	175 (5.0)	250 (7.1)	300 (8.5)	350 (9.9)	350 (9.9)
2 (0.14)	150 (4.2)	225 (6.4)	275 (7.8)	375 (10.6)	400 (11.3)	475 (13.4)	475 (13.4)
3 (0.21)	200 (5.7)	300 (8.5)	375 (10.6)	425 (12.0)	500 (14.2)	550 (15.6)	600 (17.0)
5 (0.34)	250 (7.1)	400 (11.3)	500 (14.2)	600 (17.0)	700 (19.8)	800 (22.7)	1000 (28.3)
10 (0.70)	350 (9.9)	600 (17.0)	850 (24.1)	1000 (28.3)	1200 (34.0)	1300 (36.8)	1400 (39.6)
15 (1.00)	425 (12.0)	900 (25.5)	1100 (31.2)	1500 (42.5)	1500 (42.5)	1500 (42.5)	1600 (45.3)
20 (1.40)	500 (14.2)	1100 (31.2)	1400 (39.6)	1600 (45.3)	1800 (51.0)	1800 (51.0)	1900 (53.8)
30 (2.10)	650 (18.4)	1400 (39.6)	1800 (51.0)	2100 (59.5)	2100 (59.5)	2100 (59.5)	—
40 (2.80)	800 (22.7)	1800 (51.0)	2200 (62.3)	2400 (68.0)	2500 (70.8)	—	—
60 (4.10)	1100 (31.2)	2200 (62.3)	2500 (70.8)	2500 (70.8)	—	—	—
100 (6.90)	1700 (48.1)	2400 (68.0)	2500 (70.8)	—	—	—	—
125 (8.60)	2000 (56.6)	—	—	—	—	—	—

For optimum performance, maximum inlet pressure should not exceed maximum capacity rating for any given orifice size.

1" Outlet Set Point 7.0" W.C. at 50 SCFH

SCFH (m³/h) 0.60 specific gravity gas at 60°F and 14.7 PSIA. Pressure spring 70017P044. Outlet pressure variance not to exceed +2" -1" W.C. from set point, horizontal position.

1800B2 Series Regulator Capacity SCFH (m³/h)

Inlet PSIG (bar)	1/8" x 3/16" Orifice	3/16" Orifice	1/4" Orifice	5/16" Orifice	3/8" Orifice	1/2" Orifice	9/16" Orifice
1 (0.07)	—	150 (4.2)	200 (5.7)	250 (7.1)	300 (8.5)	350 (9.9)	350 (9.9)
2 (0.14)	175 (5.0)	250 (7.1)	350 (9.9)	375 (10.6)	400 (11.3)	475 (13.4)	475 (13.4)
3 (0.21)	200 (5.7)	325 (9.2)	400 (11.3)	425 (12.0)	500 (14.2)	550 (15.6)	600 (17.0)
5 (0.34)	275 (7.8)	425 (12.0)	550 (15.6)	600 (17.0)	700 (19.8)	1000 (28.3)	1000 (28.3)
10 (0.70)	350 (9.9)	650 (18.4)	900 (25.5)	1000 (28.3)	1400 (39.6)	1500 (42.5)	1800 (51.0)
15 (1.00)	425 (12.0)	900 (25.5)	1200 (34.0)	1500 (42.5)	1800 (51.0)	2100 (59.5)	2400 (68.0)
20 (1.40)	500 (14.2)	1100 (31.2)	1600 (45.3)	1800 (51.0)	2300 (65.1)	2500 (70.8)	2500 (70.8)
30 (2.10)	650 (18.4)	1400 (39.6)	2000 (56.6)	2500 (70.8)	2500 (70.8)	2500 (70.8)	—
40 (2.80)	800 (22.7)	1800 (51.0)	2500 (70.8)	2500 (70.8)	2500 (70.8)	2500 (70.8)	—
60 (4.10)	1100 (31.2)	2400 (68.0)	2500 (70.8)	2500 (70.8)	2500 (70.8)	—	—
100 (6.90)	1700 (48.1)	2500 (70.8)	2500 (70.8)	—	—	—	—
125 (8.60)	2000 (56.6)	—	—	—	—	—	—

For optimum performance, maximum inlet pressure should not exceed maximum capacity rating for any given orifice size.

1800B2 Regulator Capacity Performance

1-1/4" Outlet Set Point 7.0" W.C. at 50 SCFH

SCFH (m³/h) 0.60 specific gravity gas at 60°F and 14.7 PSIA. Pressure spring 70017P044. Outlet pressure variance not to exceed +2" -1" W.C. from set point, horizontal position.

1800B2 Series Regulator Capacity SCFH (m³/h)

Inlet PSIG (bar)	1/8" x 3/16" Orifice	3/16" Orifice	1/4" Orifice	5/16" Orifice	3/8" Orifice	1/2" Orifice	9/16" Orifice
1 (0.07)	—	150 (4.2)	200 (5.7)	275 (7.8)	350 (9.9)	400 (11.3)	400 (11.3)
2 (0.14)	175 (5.0)	250 (7.1)	350 (9.9)	475 (13.4)	500 (14.2)	650 (18.4)	900 (25.5)
3 (0.21)	225 (6.4)	325 (9.2)	475 (13.4)	550 (15.6)	700 (19.8)	1000 (28.3)	1500 (42.5)
5 (0.34)	275 (7.8)	475 (13.4)	750 (21.2)	1000 (28.3)	1200 (34.0)	2000 (56.6)	2500 (70.8)
10 (0.70)	375 (10.6)	800 (22.7)	1500 (42.5)	2200 (62.3)	2500 (70.8)	2500 (70.8)	2500 (70.8)
15 (1.00)	450 (12.7)	1000 (28.3)	1800 (51.0)	2500 (70.8)	2500 (70.8)	2500 (70.8)	2500 (70.8)
20 (1.40)	500 (14.2)	1200 (34.0)	2100 (59.5)	2500 (70.8)	2500 (70.8)	—	—
30 (2.10)	650 (18.4)	1600 (45.3)	2500 (70.8)	—	—	—	—
40 (2.80)	800 (22.7)	1900 (53.8)	—	—	—	—	—
60 (4.10)	1100 (31.2)	—	—	—	—	—	—
100 (6.90)	1700 (48.1)	—	—	—	—	—	—

For optimum performance, maximum inlet pressure should not exceed maximum capacity rating for any given orifice size.

3/4" Outlet Set Point 2 PSIG at 50 SCFH

SCFH (m³/h) 0.60 specific gravity gas at 60°F and 14.7 PSIA. Pressure spring 70017P049. Outlet pressure variance not to exceed +/- 10% from set point, horizontal position.

1800B2 Series Regulator Capacity SCFH (m³/h)

Inlet PSIG (bar)	1/8" x 3/16" Orifice	3/16" Orifice	1/4" Orifice	5/16" Orifice	3/8" Orifice	1/2" Orifice	9/16" Orifice
3 (0.21)	—	200 (5.7)	225 (6.4)	275 (7.8)	300 (8.5)	375 (10.6)	450 (12.7)
5 (0.34)	200 (5.7)	300 (8.5)	375 (10.6)	475 (13.4)	475 (13.4)	600 (17.0)	700 (19.8)
10 (0.70)	325 (9.2)	450 (12.7)	600 (17.0)	750 (21.2)	800 (22.7)	1100 (31.2)	1200 (34.0)
15 (1.00)	425 (12.0)	600 (17.0)	800 (22.7)	1000 (28.3)	1000 (28.3)	1400 (39.6)	1500 (42.5)
20 (1.40)	500 (14.2)	750 (21.2)	1000 (28.3)	1200 (34.0)	1300 (36.8)	1600 (45.3)	1800 (51.0)
30 (2.10)	600 (17.0)	950 (26.9)	1300 (36.8)	1600 (45.3)	1700 (48.1)	2300 (65.1)	—
40 (2.80)	750 (21.2)	1200 (34.0)	1600 (45.3)	1900 (53.8)	2100 (59.5)	2500 (70.8)	—
60 (4.10)	1100 (31.2)	1600 (45.3)	2100 (59.5)	2300 (65.1)	2500 (70.8)	—	—
100 (6.90)	1600 (45.3)	2200 (62.3)	2500 (70.8)	—	—	—	—
125 (8.60)	2000 (56.6)	—	—	—	—	—	—

For optimum performance, maximum inlet pressure should not exceed maximum capacity rating for any given orifice size.

1800B2 Regulator Capacity Performance

1" Outlet Set Point 2 PSIG at 50 SCFH

SCFH (m³/h) 0.60 specific gravity gas at 60°F and 14.7 PSIA. Pressure spring 70017P049. Outlet pressure variance not to exceed +/- 10% from set point, horizontal position.

1800B2 Series Regulator Capacity SCFH (m³/h)

Inlet PSIG (bar)	1/8" x 3/16" Orifice	3/16" Orifice	1/4" Orifice	5/16" Orifice	3/8" Orifice	1/2" Orifice	9/16" Orifice
3 (0.21)	—	200 (5.7)	225 (6.4)	275 (7.8)	300 (8.5)	375 (10.6)	450 (12.7)
5 (0.34)	200 (5.7)	300 (8.5)	375 (10.6)	475 (13.4)	475 (13.4)	600 (17.0)	700 (19.8)
10 (0.70)	350 (9.9)	475 (13.4)	600 (17.0)	750 (21.2)	850 (24.1)	1200 (34.0)	1300 (36.8)
15 (1.00)	425 (12.0)	650 (18.4)	850 (24.1)	1000 (28.3)	1100 (31.2)	1500 (42.5)	1700 (48.1)
20 (1.40)	500 (14.2)	800 (22.7)	1100 (31.2)	1300 (36.8)	1400 (39.6)	2000 (56.6)	2300 (65.1)
30 (2.10)	650 (18.4)	1000 (28.3)	1500 (42.5)	1800 (51.0)	2000 (56.6)	2500 (70.8)	—
40 (2.80)	800 (22.7)	1300 (36.8)	1900 (53.8)	2400 (68.0)	2500 (70.8)	2500 (70.8)	—
60 (4.10)	1100 (31.2)	2100 (59.5)	2500 (70.8)	2500 (70.8)	2500 (70.8)	—	—
100 (6.90)	1600 (45.3)	2500 (70.8)	2500 (70.8)	—	—	—	—
125 (8.60)	2000 (56.6)	—	—	—	—	—	—

For optimum performance, maximum inlet pressure should not exceed maximum capacity rating for any given orifice size.

1-1/4" Outlet Set Point 2 PSIG at 50 SCFH

SCFH (m³/h) 0.60 specific gravity gas at 60°F and 14.7 PSIA. Pressure spring 70017P049. Outlet pressure variance not to exceed +/- 10% from set point, horizontal position.

1800B2 Series Regulator Capacity SCFH (m³/h)

Inlet PSIG (bar)	1/8" x 3/16" Orifice	3/16" Orifice	1/4" Orifice	5/16" Orifice	3/8" Orifice	1/2" Orifice	9/16" Orifice
3 (0.21)	—	200 (5.7)	225 (6.4)	275 (7.8)	300 (8.5)	375 (10.6)	450 (12.7)
5 (0.34)	200 (5.7)	300 (8.5)	375 (10.6)	475 (13.4)	500 (14.2)	600 (17.0)	750 (21.2)
10 (0.70)	350 (9.9)	500 (14.2)	600 (17.0)	750 (21.2)	950 (26.9)	1200 (34.0)	1400 (39.6)
15 (1.00)	425 (12.0)	650 (18.4)	850 (24.1)	1100 (31.2)	1300 (36.8)	1800 (51.0)	2100 (59.5)
20 (1.40)	500 (14.2)	850 (24.1)	1100 (31.2)	1400 (39.6)	1700 (48.1)	2400 (68.0)	2500 (70.8)
30 (2.10)	650 (18.4)	1100 (31.2)	1600 (45.3)	2300 (65.1)	2500 (70.8)	2500 (70.8)	—
40 (2.80)	800 (22.7)	1500 (42.5)	2200 (62.3)	2500 (70.8)	2500 (70.8)	2500 (70.8)	—
60 (4.10)	1100 (31.2)	2400 (68.0)	2500 (70.8)	2500 (70.8)	2500 (70.8)	—	—
100 (6.90)	1700 (48.1)	2500 (70.8)	2500 (70.8)	—	—	—	—
125 (8.60)	2100 (59.5)	—	—	—	—	—	—

For optimum performance, maximum inlet pressure should not exceed maximum capacity rating for any given orifice size.

1800B2-HC Regulator

Ideal for light commercial and industrial use, the 1-1/4" 1800B2-HC Series regulator is designed to increase output capacity during medium to high inlet pressure operations.

General Information

The 1800B2-HC Series regulator's lightweight design features high-capacity capabilities for 1-1/4" NPT connections and flow capacities up to 4600 SCFH depending on inlet pressure and orifice selection. It complements the 1800B2 Series family of regulators.



AC-630 Meter with 1813B2-HC Regulator

1800B2-HC Regulator Capacity Performance

1-1/4" Outlet
Set Point 7.0" W.C.
at 50 SCFH

SCFH (m³/h) 0.60 specific gravity gas at 60°F and 14.7 PSIA. Pressure spring 70017P044. Outlet pressure variance not to exceed +2" -1" W.C. from set point, horizontal position.

1800B2-HC Series Regulator Capacity SCFH (m³/h)

Inlet PSIG (bar)	1/8" x 3/16" Orifice	3/16" Orifice	1/4" Orifice	5/16" Orifice	3/8" Orifice	1/2" Orifice	9/16" Orifice
1 (0.07)	—	150 (4.2)	225 (6.4)	225 (6.4)	200 (4.2)	325 (9.2)	300 (8.5)
2 (0.14)	150 (4.2)	200 (5.7)	275 (7.8)	300 (8.5)	350 (9.9)	375 (10.6)	450 (12.7)
3 (0.21)	200 (5.7)	250 (7.1)	350 (9.9)	350 (9.9)	425 (12.0)	600 (17.0)	600 (17.0)
5 (0.34)	250 (7.1)	350 (9.9)	425 (12.0)	500 (14.2)	600 (17.0)	750 (21.2)	850 (24.1)
10 (0.70)	350 (9.9)	500 (14.2)	650 (18.4)	800 (22.7)	800 (22.7)	1500 (42.5)	1700 (48.1)
15 (1.00)	425 (12.0)	600 (17.0)	900 (25.5)	950 (26.9)	1500 (42.5)	2200 (62.3)	2300 (65.1)
20 (1.40)	500 (14.2)	750 (21.2)	1000 (28.3)	2100 (59.4)	2200 (62.3)	2700 (76.4)	2900 (82.1)
30 (2.10)	650 (18.4)	1200 (34.0)	1700 (48.1)	3600 (101.9)	3000 (84.9)	3900 (110.4)	—
40 (2.80)	800 (22.7)	1650 (46.7)	2600 (73.6)	4300 (121.7)	4100 (116.0)	—	—
60 (4.10)	1100 (31.2)	2500 (70.8)	4500 (127.4)	4600 (130.2)	3900 (110.4)	—	—
100 (6.90)	1700 (48.1)	3900 (110.4)	—	—	—	—	—
125 (8.60)	1900 (53.8)	—	—	—	—	—	—

For optimum performance, maximum inlet pressure should not exceed maximum capacity rating for any given orifice size.

1800B2 and 1800B2-HC Series Service Regulators - Other Technical Data

Full-Open Regulator Relief Capacity

For sizing downstream relief valves, use the following formulas to determine the regulator full-open capacity:

Critical flow rates Sub-critical flows

$$Q = 0.5 C \times \frac{P_1}{\sqrt{G}} \quad Q = C \times \frac{\sqrt{P_2 h}}{\sqrt{G}}$$

Critical flow occurs when the absolute outlet pressure is less than about 1/2 of the absolute inlet pressure.

- Q Maximum capacity of regulator
- C Orifice constant (see table below)
- P_1 Inlet absolute pressure (PSIA)
- P_2 Outlet absolute pressure (PSIA)
- h Differential pressure
- G Specific gravity of gas

Orifice Constants

Orifice	C
1/8"	25
1/8" x 3/16"	25
3/16"	57
1/4"	98
5/16"	149
3/8"	208
1/2"	353
9/16"	421

Maximum Recommended Inlet Pressure

Orifice Size	Inlet Pressure (PSIG)
9/16"	20
1/2"	40
3/8"	100
5/16"	110
1/4"	125
3/16"	125
1/8" x 3/16"	125
1/8"	125

This is the maximum inlet the regulator should operate at to insure complete lockup at no-flow conditions.

Other Gas Capacities

To determine the capacity of these regulators for gases other than natural gas, multiply the values within the capacity tables by a Specific Gravity Conversion Factor (F_g). The table below lists this factor for some of the more common gases.

Gas Type	Specific Gravity	Conversion Factor (F_g)
Air	1.00	0.77
Butane	2.01	0.55
Carbon Dioxide	1.52	0.63
Nitrogen	0.97	0.79
Propane	1.53	0.63

To calculate the Conversion Factor for other gases:

$$(F_g) = \sqrt{\frac{\text{Specific gravity of gas on which the capacity table is based}}{\text{Specific gravity of gas being used}}}$$

Example: If using propane and only having tables based on natural gas, the Specific Gravity Conversion Factor is:

$$(F_g) = \sqrt{\frac{\text{Specific gravity of natural gas (0.6)}}{\text{Specific gravity of propane (1.53)}}}$$

$$(F_g) = \sqrt{\frac{0.60}{1.53}}$$

$$(F_g) = 0.626$$

Regulator Pressure Rating

125 PSIG (8.6 bar) = Maximum recommended inlet pressure for normal service. Maximum recommended pressure may vary with orifice size.

175 PSIG (12 bar) = Maximum inlet pressure for abnormal or emergency service, without causing damage to regulator case.

2 PSIG (138 mbar) = Maximum outlet pressure for normal service.

10 PSIG (689 mbar) = Maximum outlet pressure which can be contained by pressure carrying components (no flange leakage to atmosphere except for normal relief action). **If regulator is subjected to these conditions, it should be removed from service.**

50 PSIG (3.5 bar) = Maximum outlet pressure for abnormal service without damage to internal components. **If regulator is subjected to these conditions, it should be removed from service.**

1800B2 and 1800B2-HC Service Regulators

Regulator Relief Valve Performance

There are several methods of measuring the relief performance of a regulator. The worst case scenario will occur when the lever is disconnected. The data presented in the tables below represent this condition.

Outlet Pressure Relative to Inlet Pressure

3/4" Screened Vent – No Vent Pipe Set Pressure 7" W.C.

Outlet Pressure - Inches W.C. (mbar)

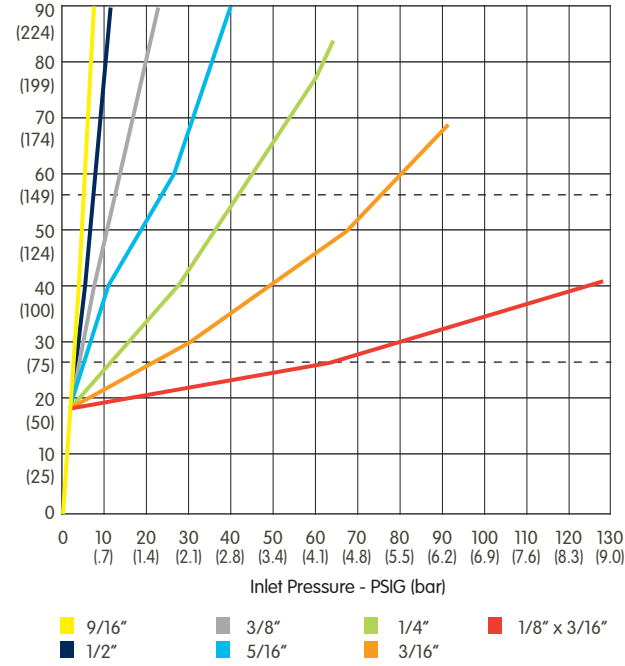

1" Screened Vent – No Vent Pipe Set Pressure 7" W.C.

Outlet Pressure - Inches W.C. (mbar)

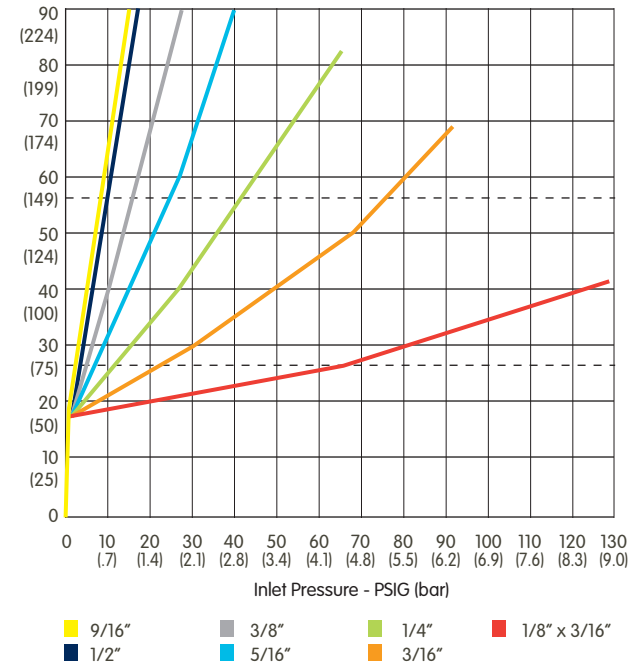

3/4" Screened Vent – No Vent Pipe Set Pressure 2 PSIG

Outlet Pressure - Inches W.C. (mbar)

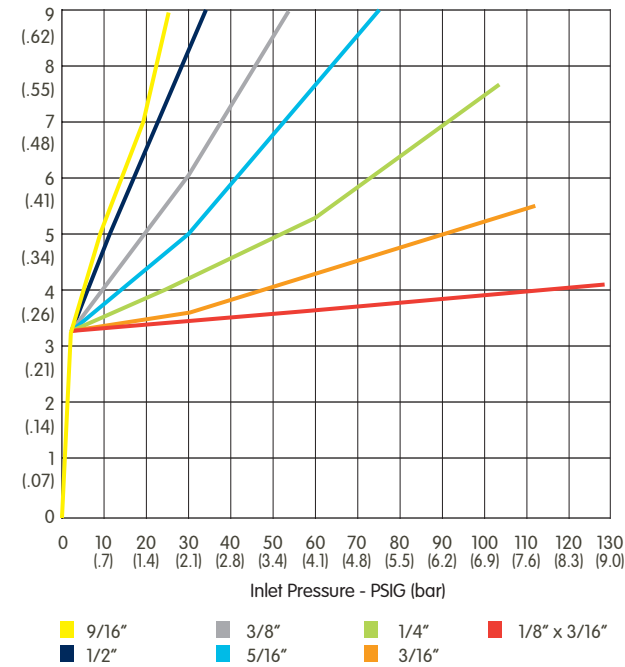

1" Screened Vent – No Vent Pipe Set Pressure 2 PSIG

Outlet Pressure - Inches W.C. (mbar)

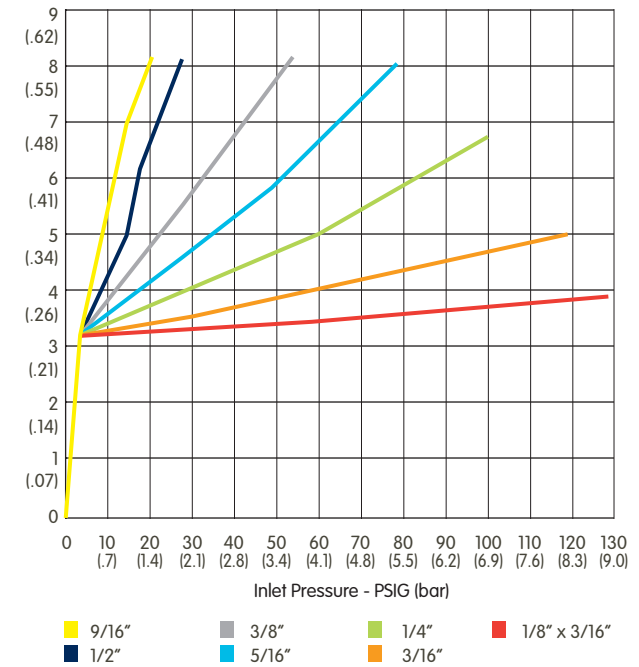

1843B2-L Regulator with Limited Relief

The 1843B2-L has a limited relief feature that reduces the amount of gas released to the atmosphere.

General Information

Limited Relief is accomplished by installing a relief restriction cup inside the diaphragm assembly of the 1843B2 regulator. The 1843B2-L regulator utilizes overpressure protection as part of its assembly, which will shut off the gas in the event of over pressure condition.

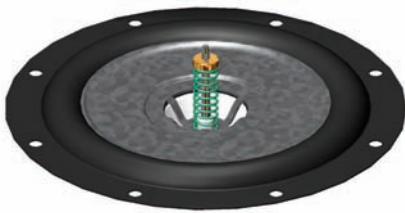

Full Relief Diaphragm Assembly

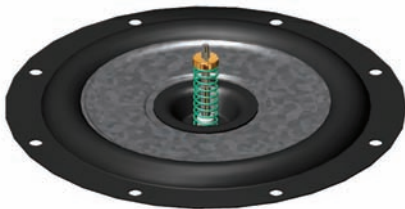

Limited Relief Diaphragm Assembly

Under regulator lockup conditions, an increase in gas temperature or very small gas leakage through the orifice can raise the outlet gas pressure. The limited relief will release this small increase in outlet pressure to atmosphere without the OPSO tripping. But should the outlet pressure continue to increase for some reason, then the OPSO will shut off and close off the gas flow.

3/8" O/D minimum pipe size is recommended should the relief connection require piping to a safe location. Care must be taken to prevent water from closing off or entering into the vent opening. Any kind of blockage of the vent or vent pipe must be prevented.

To the right is a graphical representation of the difference of gas flow between a standard relief valve and a limited relief valve.

Flow Through Vent

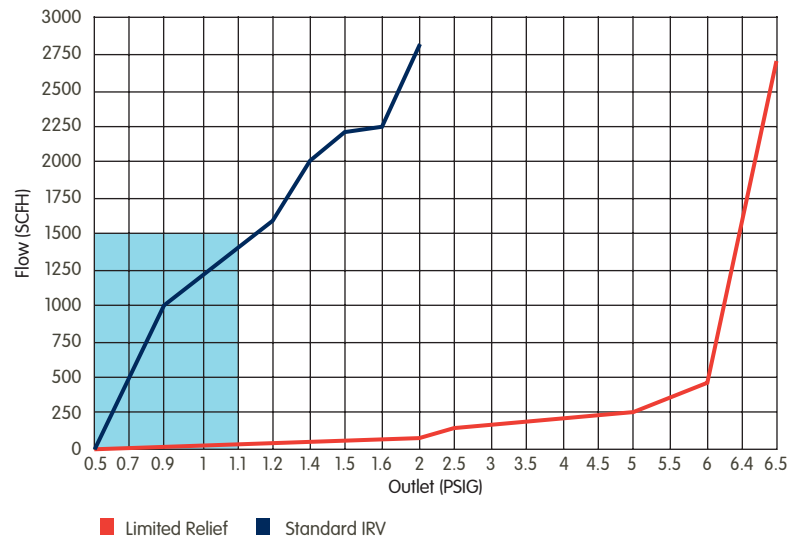

Flow Through Vent - Enlarged View of Tinted Area

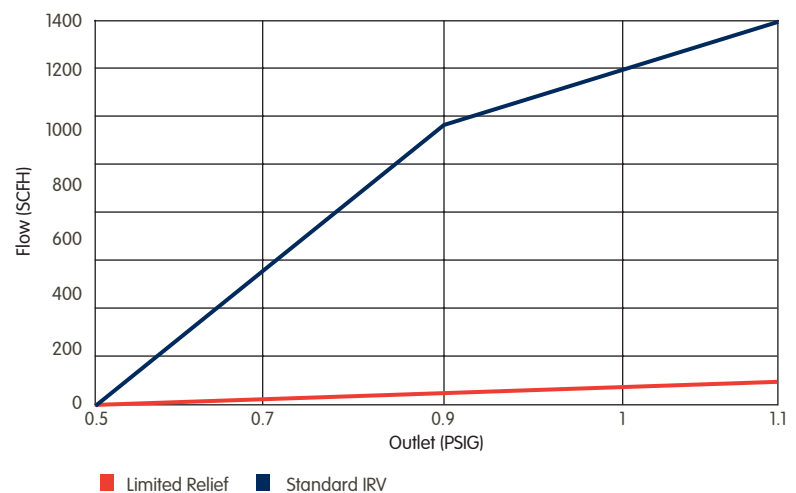

1800B2 and 1800B2-HC Series Service Regulator Dimensions

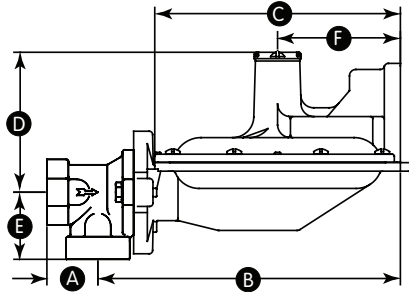

Model 1803B2, 1803B2-HC, 1813B2, and 1813B2-HC - 90°

Inlet	Outlet	A	B	C	D	E	F
3/4"	3/4"	1-9/16" 39.7mm	8-7/8" 225.4mm	7-1/4" 184.2mm	4-1/8" 104.8mm	2" 50.8mm	3-5/8" 92.1mm
3/4"	1"	1-9/16" 39.7mm	8-7/8" 225.4mm	7-1/4" 184.2mm	4-1/8" 104.8mm	2" 50.8mm	3-5/8" 92.1mm
1"	1"	1-9/16" 39.7mm	8-7/8" 225.4mm	7-1/4" 184.2mm	4-1/8" 104.8mm	2" 50.8mm	3-5/8" 92.1mm

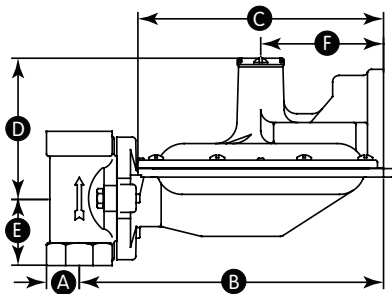

Model 1803B2, 1803B2-HC, 1813B2, and 1813B2-HC - 180°

Inlet	Outlet	A	B	C	D	E	F
3/4"	3/4"	1" 25.4mm	8-7/8" 225.4mm	7-1/4" 184.2mm	4-1/8" 104.8mm	2" 50.8mm	3-5/8" 92.1mm
3/4"	1"	1" 25.4mm	8-7/8" 225.4mm	7-1/4" 184.2mm	4-1/8" 104.8mm	2" 50.8mm	3-5/8" 92.1mm
1"	1"	1" 25.4mm	8-7/8" 225.4mm	7-1/4" 184.2mm	4-1/8" 104.8mm	2" 50.8mm	3-5/8" 92.1mm
1"	1-1/4"	1-1/8" 28.6mm	8-7/8" 225.4mm	7-1/4" 184.2mm	4-1/8" 104.8mm	2" 50.8mm	3-5/8" 92.1mm
1-1/4"	1-1/4"	1-1/8" 28.6mm	8-7/8" 225.4mm	7-1/4" 184.2mm	4-1/8" 104.8mm	2" 50.8mm	3-5/8" 92.1mm
3/4"	1-1/4"	1-1/8" 28.6mm	8-7/8" 225.4mm	7-1/4" 184.2mm	4-1/8" 104.8mm	2" 50.8mm	3-5/8" 92.1mm

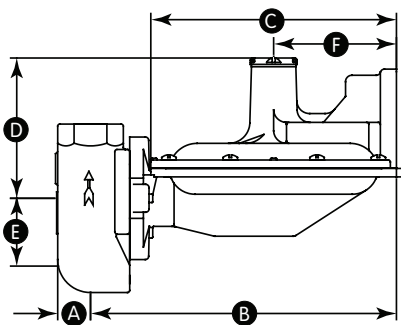

Model 1803B2 and 1813B2 - Offset

Inlet	Outlet	A	B	C	D	E	F
3/4"	3/4"	1" 25.4mm	8-7/8" 225.4mm	7-1/4" 184.2mm	4-1/8" 104.8mm	2" 50.8mm	3-5/8" 92.1mm
3/4"	1"	1" 25.4mm	8-7/8" 225.4mm	7-1/4" 184.2mm	4-1/8" 104.8mm	2" 50.8mm	3-5/8" 92.1mm
1"	1"	1" 25.4mm	8-7/8" 225.4mm	7-1/4" 184.2mm	4-1/8" 104.8mm	2" 50.8mm	3-5/8" 92.1mm

1800B2 and 1800B2-HC Series Service Regulator Dimensions

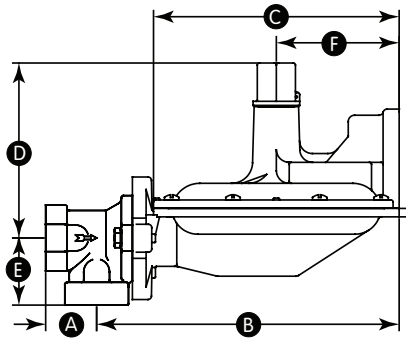

Model 1823B2 and 1833B2 - 90°

Inlet	Outlet	A	B	C	D	E	F
3/4"	3/4"	1-9/16" 39.7mm	8-7/8" 225.4mm	7-1/4" 184.2mm	5-1/8" 130.2mm	2" 50.8mm	3-5/8" 92.1mm
3/4"	1"	1-9/16" 39.7mm	8-7/8" 225.4mm	7-1/4" 184.2mm	5-1/8" 130.2mm	2" 50.8mm	3-5/8" 92.1mm
1"	1"	1-9/16" 39.7mm	8-7/8" 225.4mm	7-1/4" 184.2mm	5-1/8" 130.2mm	2" 50.8mm	3-5/8" 92.1mm

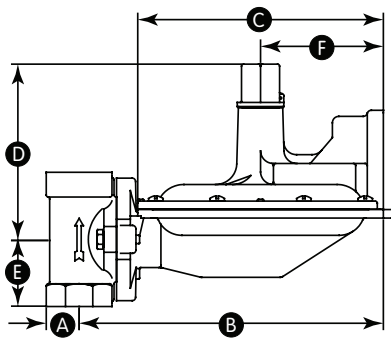

Model 1823B2 and 1833B2 - 180°

Inlet	Outlet	A	B	C	D	E	F
3/4"	3/4"	1" 25.4mm	8-7/8" 225.4mm	7-1/4" 184.2mm	5-1/8" 130.2mm	2" 50.8mm	3-5/8" 92.1mm
3/4"	1"	1" 25.4mm	8-7/8" 225.4mm	7-1/4" 184.2mm	5-1/8" 130.2mm	2" 50.8mm	3-5/8" 92.1mm
1"	1"	1" 25.4mm	8-7/8" 225.4mm	7-1/4" 184.2mm	5-1/8" 130.2mm	2" 50.8mm	3-5/8" 92.1mm
1"	1-1/4"	1-1/8" 28.6mm	8-7/8" 225.4mm	7-1/4" 184.2mm	5-1/8" 130.2mm	2" 50.8mm	3-5/8" 92.1mm
1-1/4"	1-1/4"	1-1/8" 28.6mm	8-7/8" 225.4mm	7-1/4" 184.2mm	5-1/8" 130.2mm	2" 50.8mm	3-5/8" 92.1mm
3/4"	1-1/4"	1-1/8" 28.6mm	8-7/8" 225.4mm	7-1/4" 184.2mm	5-1/8" 130.2mm	2" 50.8mm	3-5/8" 92.1mm

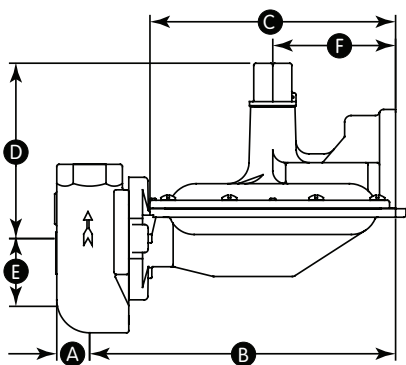

Model 1823B2 and 1833B2 - Offset

Inlet	Outlet	A	B	C	D	E	F
3/4"	3/4"	1" 25.4mm	8-7/8" 225.4mm	7-1/4" 184.2mm	5-1/8" 130.2mm	2" 50.8mm	3-5/8" 92.1mm
3/4"	1"	1" 25.4mm	8-7/8" 225.4mm	7-1/4" 184.2mm	5-1/8" 130.2mm	2" 50.8mm	3-5/8" 92.1mm
1"	1"	1" 25.4mm	8-7/8" 225.4mm	7-1/4" 184.2mm	5-1/8" 130.2mm	2" 50.8mm	3-5/8" 92.1mm

1800B2 and 1800B2-HC Series Service Regulator Dimensions

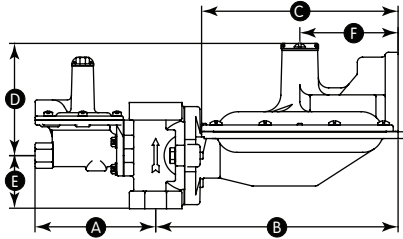

Model 1843B2, 1843B2-HC, 1883B2 and 1883B2-HC

Inlet	Outlet	A	B	C	D	E	F
3/4"	3/4"	4-1/2" 114.3mm	8-15/16" 227.0mm	7-1/4" 184.2mm	4-1/8" 104.8mm	2" 50.8mm	3-5/8" 92.1mm
3/4"	1"	4-1/2" 114.3mm	8-15/16" 227.0mm	7-1/4" 184.2mm	4-1/8" 104.8mm	2" 50.8mm	3-5/8" 92.1mm
1"	1"	4-1/2" 114.3mm	8-15/16" 227.0mm	7-1/4" 184.2mm	4-1/8" 104.8mm	2" 50.8mm	3-5/8" 92.1mm
1"	1-1/4"	4-1/2" 114.3mm	8-15/16" 227.0mm	7-1/4" 184.2mm	4-1/8" 104.8mm	2" 50.8mm	3-5/8" 92.1mm
1-1/4"	1-1/4"	4-1/2" 114.3mm	8-15/16" 227.0mm	7-1/4" 184.2mm	4-1/8" 104.8mm	2" 50.8mm	3-5/8" 92.1mm

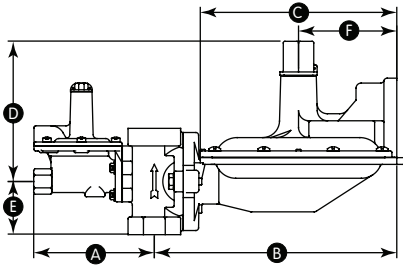

Model 1853B2 and 1893B2

Inlet	Outlet	A	B	C	D	E	F
3/4"	3/4"	4-1/2" 114.3mm	8-15/16" 227.0mm	7-1/4" 184.2mm	5-1/8" 130.2mm	2" 50.8mm	3-5/8" 92.1mm
3/4"	1"	4-1/2" 114.3mm	8-15/16" 227.0mm	7-1/4" 184.2mm	5-1/8" 130.2mm	2" 50.8mm	3-5/8" 92.1mm
1"	1"	4-1/2" 114.3mm	8-15/16" 227.0mm	7-1/4" 184.2mm	5-1/8" 130.2mm	2" 50.8mm	3-5/8" 92.1mm
1"	1-1/4"	4-1/2" 114.3mm	8-15/16" 227.0mm	7-1/4" 184.2mm	5-1/8" 130.2mm	2" 50.8mm	3-5/8" 92.1mm
1-1/4"	1-1/4"	4-1/2" 114.3mm	8-15/16" 227.0mm	7-1/4" 184.2mm	5-1/8" 130.2mm	2" 50.8mm	3-5/8" 92.1mm

Regulator Assembly Positions

180° Models

Valve Head Position "A"

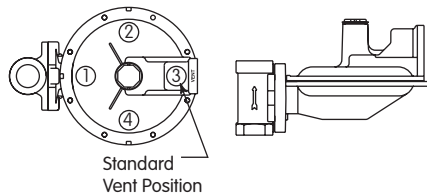

Valve Head Position "B"

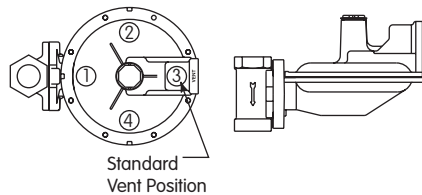

Valve Head Position "C"

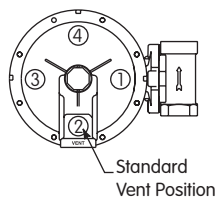

Valve Head Position "D"

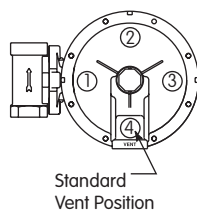

AC-250 Meter with 1813B2 Regulator

Example of Regulator Assembly Position

In the photo above the 1813B2 Regulator shown has an 180 degree valve head in Position "C" (Flow upward) with the vent in position 2 (Looking down). This would be assembly position C2.

90° Models

Valve Head Position "A"

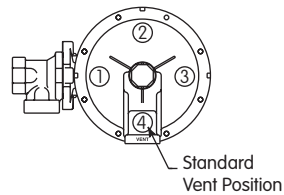

Valve Head Position "B"

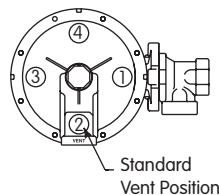

Valve Head Position "C"

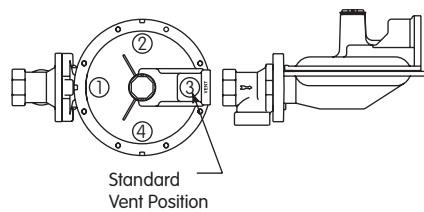

Valve Head Position "D"

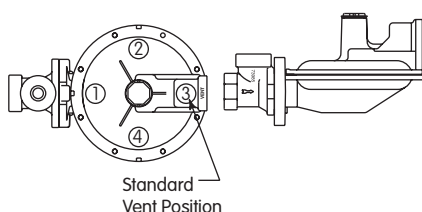

Ordering Information

- 1 Model number
- 2 Size of inlet and outlet
- 3 Inlet pressure, PSIG (bar)
- 4 Outlet pressure, inches W.C. (mbar) or PSIG (bar)
- 5 Flow, SCFH (m3/h)
- 6 Kind and specific gravity of gas
- 7 Orifice size
- 8 Regulator assembly position number
- 9 Possible variation in inlet pressure for E.C. Orifice models
Maximum ___ PSIG (bar)
Minimum ___ PSIG (bar)

Offset Models

Valve Head Position "D"

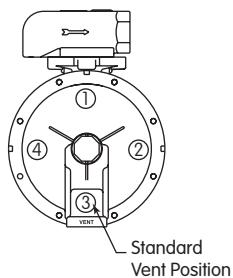

Shipping Weight

17.5 lbs/carton of four regulators

About Elster Group

A world leader in advanced metering infrastructure, integrated metering, and utilization solutions to the gas, electricity and water industries, Elster's systems and solutions reflect over 170 years of knowledge and experience in measuring precious resources and energy.

Elster provides solutions and advanced technologies to help utilities more easily, efficiently and reliably obtain and use advanced metering intelligence to improve customer service, enhance operational efficiency, and increase revenues. Elster's AMI solutions enable utilities to cost-effectively generate, deliver, manage, and conserve the life-essential resources of gas, electricity, and water.

Elster has over 7500 staff and operations in 38 countries in North and South America, Europe, and Asia.

ISO 9001: 2000



Certificate No. 006697

Authorised Distributor:



46, Jalan SS 22/21, Damansara Jaya,
47400 Petaling Jaya, Selangor Darul Ehsan, Malaysia.

Email: nog@nog.com.my

Web access: <http://www.nog.com.my>

© 2008 Elster American Meter. All rights reserved.

Information contained herein is subject to change without notice. Product specifications may change. Contact your Elster American Meter representative for the most current product information. Printed in the United States.

EAM-TB8510.8-EN-P - April 2008

Supersedes SB 8510.7, TDB-8620.2 and TDB-8622.1